

7200 Front-Fold MaxEmerge®2 Drawn Conservation Planters

**John Deere Harvester Works
TM1366 (06JAN97)**

LITHO IN U.S.A.
ENGLISH

Introduction

FOREWORD

This manual is written for an experienced technician. Essential tools required in performing certain service work are identified in this manual and are recommended for use.

Live with safety: Read the safety messages in the introduction of this manual and the cautions presented throughout the text of the manual.



This is the safety-alert symbol. When you see this symbol on the machine or in this manual, be alert to the potential for personal injury.

Technical manuals are divided in two parts: repair and operation and tests. Repair sections tell how to repair the components. Operation and tests sections help you identify the majority of routine failures quickly.

Information is organized in groups for the various components requiring service instruction. At the beginning of each group are summary listings of all applicable essential tools, service equipment and tools, other materials needed to do the job, service parts kits, specifications, wear tolerances, and torque values.

Technical Manuals are concise guides for specific machines. They are on-the-job guides containing only the vital information needed for diagnosis, analysis, testing, and repair.

Fundamental service information is available from other sources covering basic theory of operation, fundamentals of troubleshooting, general maintenance, and basic type of failures and their causes.

TO JOHN DEERE DEALERS:

IMPORTANT: Please remove this page and route through your service department.

This is a complete revision for TM-1366, 7200 Front-Fold MaxEmerge[®] 2 Drawn Conservation Planters, 8-Row Wide and 12-Row Narrow Flex-Fold, 12-Row Narrow Rigid-Fold Frame, 16-Row Narrow Flex-Fold Frame, and 24-Row Narrow Flex-Fold Frame.

Binder and tabs from old manual may be saved and used with this bound manual.

Listed is a brief explanation of “WHAT” was changed and “WHY” it was changed.

This manual was revised to include:

1. New 21 pin wiring harness connector to console.
2. OPTIONAL fold down markers for 12 row planters.
3. Vacuum blower control valve.
4. 12 row narrow flex-fold wing lock out valve.
5. Marker sequence valve for 12 row planters.
6. General update.

Contents

SECTION 10—General Information

- Group 05—Safety
- Group 10—Specifications
- Group 15—Predelivery, Delivery and After-Sale Services
- Group 20—Lubrication

SECTION 20—Electrical

- Group 05—Specifications
- Group 10—Warning Lamp
- Group 15—Operation
- Group 20—Diagnosing and Testing

SECTION 30—Hydraulic

- Group 05—Specifications
- Group 10—Operation
- Group 15—Vacuum Meter
- Group 20—Cylinders
- Group 25—Flow Dividers
- Group 30—Solenoid Valves

SECTION 40—Drives

- Group 05—Specifications
- Group 10—Drive Wheels
- Group 15—Countershaft Drive System
- Group 20—Seed Drive Transmission
- Group 25—Clutch
- Group 30—Fertilizer Drive

SECTION 50—Planting Units

- Group 05—Vacuum Seed Metering Mechanisms
- Group 10—Plateless Seed Metering Mechanisms
- Group 15—Plate Meter
- Group 20—Checking Seed Population
- Group 25—Seed Openers
- Group 30—Closing Wheels
- Group 35—Insecticide/Herbicide Meter
- Group 40—Coulter/Single-Disk Fertilizer Opener

SECTION 60—Planter Run-In

- Group 05—Planter Run-In

SECTION 70—Population Check In Field

- Group 05—General Information

Index

10

20

30

40

50

60

70

INDX

Section 10 General Information

Contents

Page

Group 05—Safety	10-05-1
Group 10—Specifications	10-10-1
Group 15—Predelivery, Delivery and After-Sale Services	10-15-1
Group 20—Lubrication	
General Purpose Grease	10-20-1
Lubrication Symbols	10-20-2
Roller Chain and Pesticide Gear Lubrication	10-20-3
PTO Drive Hydraulic Pump for Vacuum Meter	10-20-4
Wheel Arms and Cylinder Pins	10-20-4
Gauge Wheels, Tillage Bracket and Hitch	10-20-5
Hitch	10-20-5
Drawbar Pin, Hinge Pin and Pivot Pins	10-20-5
Pivot Pins	10-20-6
Seed Transmission Drive Chains	10-20-6
Single-Disk Fertilizer Opener	10-20-7
Unit Mounted Coulter	10-20-7
Fertilizer Drive Chain	10-20-8
Shut Off Valve and Hinge Pin	10-20-9
12-Row Rigid-Fold	10-20-9
16- and 24-Row Narrow	10-20-10
Alternative Lubricants and Special Lubricants	10-20-12
Special Lubricants for Vacuum Seed Meters	10-20-12
Finger Pickup and Plate Meters Only	10-20-13

HANDLE FLUIDS SAFELY—AVOID FIRES

When you work around fuel, do not smoke or work near heaters or other fire hazards.

Store flammable fluids away from fire hazards. Do not incinerate or puncture pressurized containers.

Make sure machine is clean of trash, grease, and debris.

Do not store oily rags; they can ignite and burn spontaneously.



DX,FLAME -19-04JUN90

10-05-1
-JUN-23AUG88
TS227

PREVENT BATTERY EXPLOSIONS

Keep sparks, lighted matches, and open flame away from the top of battery. Battery gas can explode.

Never check battery charge by placing a metal object across the posts. Use a volt-meter or hydrometer.

Do not charge a frozen battery; it may explode. Warm battery to 16°C (60°F).

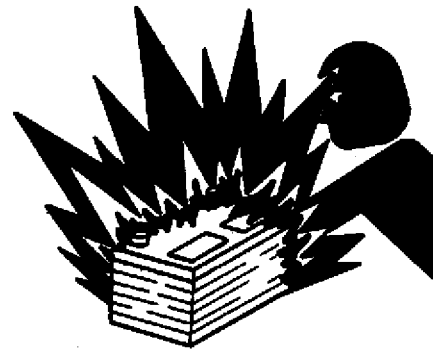

DX,SPARKS -19-03MAR93

-JUN-23AUG88
TS204

PREPARE FOR EMERGENCIES

Be prepared if a fire starts.

Keep a first aid kit and fire extinguisher handy.

Keep emergency numbers for doctors, ambulance service, hospital, and fire department near your telephone.

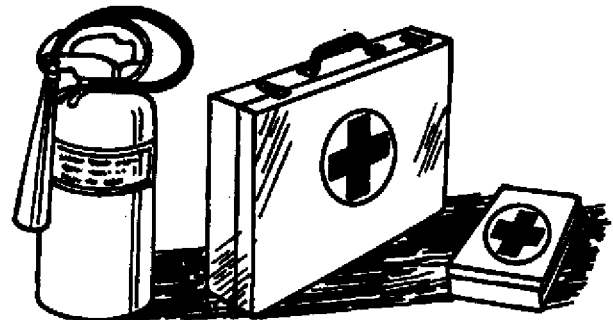

DX,FIRE2 -19-03MAR93

-JUN-23AUG88
TS291

10
05
2

AVOID HIGH-PRESSURE FLUIDS

Escaping fluid under pressure can penetrate the skin causing serious injury.

Avoid the hazard by relieving pressure before disconnecting hydraulic or other lines. Tighten all connections before applying pressure.

Search for leaks with a piece of cardboard. Protect hands and body from high pressure fluids.

If an accident occurs, see a doctor immediately. Any fluid injected into the skin must be surgically removed within a few hours or gangrene may result. Doctors unfamiliar with this type of injury should reference a knowledgeable medical source. Such information is available from Deere & Company Medical Department in Moline, Illinois, U.S.A.

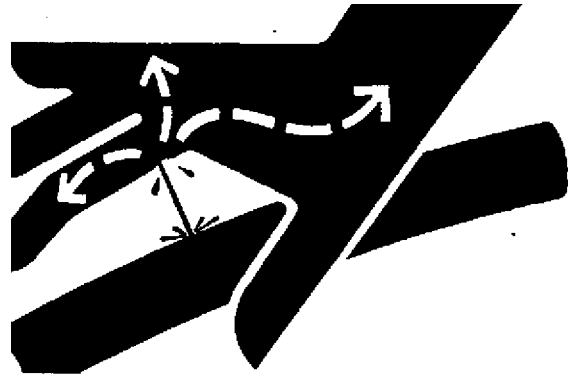

-JUN-23AUG88

X9811

DX,FLUID -19-03MAR93

PARK MACHINE SAFELY

Before working on the machine:

- Lower all equipment to the ground.
- Stop the engine and remove the key.
- Disconnect the battery ground strap.
- Hang a "DO NOT OPERATE" tag in operator station.

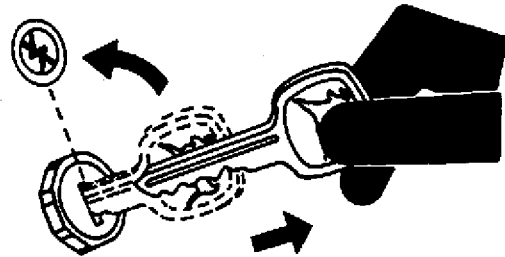

-JUN-24MAY89

TS230

DX,PARK -19-04JUN90

SUPPORT MACHINE PROPERLY

Always lower the attachment or implement to the ground before you work on the machine. If you must work on a lifted machine or attachment, securely support the machine or attachment.

Do not support the machine on cinder blocks, hollow tiles, or props that may crumble under continuous load. Do not work under a machine that is supported solely by a jack. Follow recommended procedures in this manual.

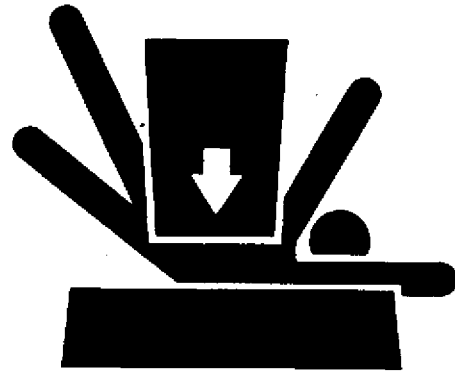

DX,LOWER -19-04JUN90

10
3
-JUN-23AUG88
TS229

WEAR PROTECTIVE CLOTHING

Wear close fitting clothing and safety equipment appropriate to the job.

Prolonged exposure to loud noise can cause impairment or loss of hearing.

Wear a suitable hearing protective device such as earmuffs or earplugs to protect against objectionable or uncomfortable loud noises.

Operating equipment safely requires the full attention of the operator. Do not wear radio or music headphones while operating machine.

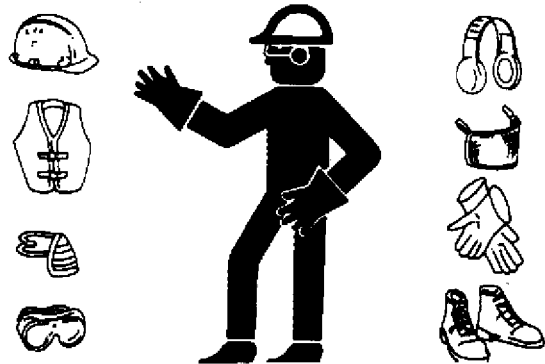

DX,WEAR -19-10SEP90

-JUN-23AUG88
TS206

SERVICE MACHINES SAFELY

Tie long hair behind your head. Do not wear a necktie, scarf, loose clothing, or necklace when you work near machine tools or moving parts. If these items were to get caught, severe injury could result.

Remove rings and other jewelry to prevent electrical shorts and entanglement in moving parts.

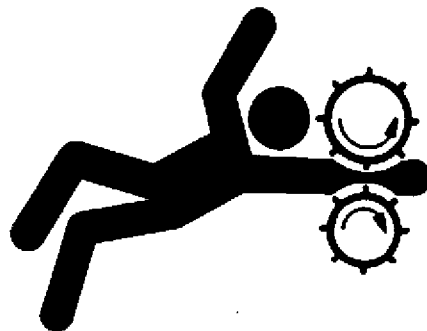

DX,LOOSE -19-04JUN90

-JUN-23AUG88
TS228

10
05
4

WORK IN VENTILATED AREA

Engine exhaust fumes can cause sickness or death. If it is necessary to run an engine in an enclosed area, remove the exhaust fumes from the area with an exhaust pipe extension.

If you do not have an exhaust pipe extension, open the doors and get outside air into the area.

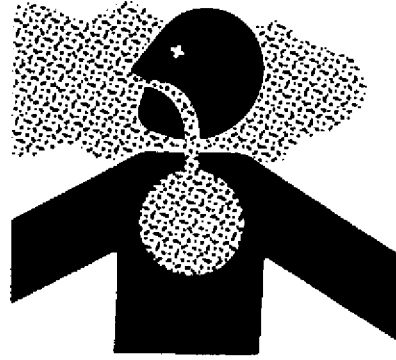

DX,AIR -19-04JUN90

TS220 -JUN-23AUG88

WORK IN CLEAN AREA

Before starting a job:

- Clean work area and machine.
- Make sure you have all necessary tools to do your job.
- Have the right parts on hand.
- Read all instructions thoroughly; do not attempt shortcuts.

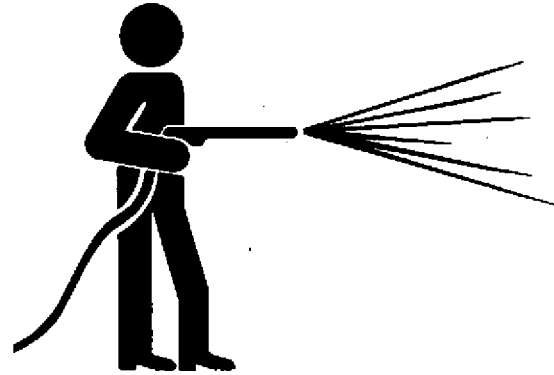

DX,CLEAN -19-04JUN90

T6642EJ -JUN-18OCT88

REMOVE PAINT BEFORE WELDING OR HEATING

Avoid potentially toxic fumes and dust.

Hazardous fumes can be generated when paint is heated by welding, soldering, or using a torch.

Do all work outside or in a well ventilated area. Dispose of paint and solvent properly.

Remove paint before welding or heating:

- If you sand or grind paint, avoid breathing the dust. Wear an approved respirator.
- If you use solvent or paint stripper, remove stripper with soap and water before welding. Remove solvent or paint stripper containers and other flammable material from area. Allow fumes to disperse at least 15 minutes before welding or heating.

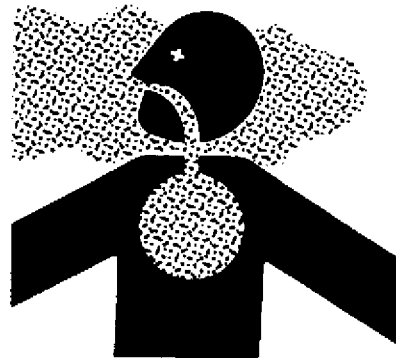

DX,PAINT -19-03MAR93

TS220 -JUN-23AUG88

AVOID HEATING NEAR PRESSURIZED FLUID LINES

Flammable spray can be generated by heating near pressurized fluid lines, resulting in severe burns to yourself and bystanders. Do not heat by welding, soldering, or using a torch near pressurized fluid lines or other flammable materials. Pressurized lines can be accidentally cut when heat goes beyond the immediate flame area.



DX,TORCH -19-03MAR93

510
-JUN-15MAY90
TS953

ILLUMINATE WORK AREA SAFELY

Illuminate your work area adequately but safely. Use a portable safety light for working inside or under the machine. Make sure the bulb is enclosed by a wire cage. The hot filament of an accidentally broken bulb can ignite spilled fuel or oil.



DX,LIGHT -19-04JUN90

-JUN-23AUG88
TS223

REPLACE SAFETY SIGNS

Replace missing or damaged safety signs. See the machine operator's manual for correct safety sign placement.

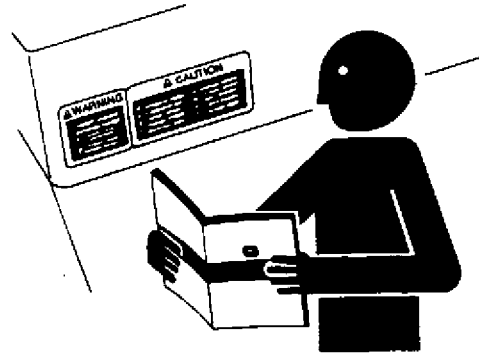

DX,SIGNS1 -19-04JUN90

-JUN-23AUG88
TS201

USE PROPER LIFTING EQUIPMENT

Lifting heavy components incorrectly can cause severe injury or machine damage.

Follow recommended procedure for removal and installation of components in the manual.

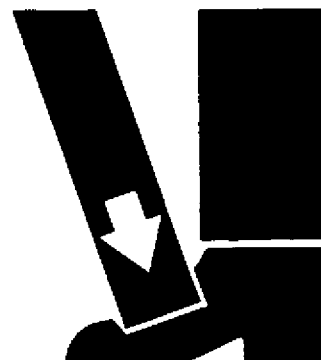

DX,LIFT -19-04JUN90

-JUN-23AUG88
TS226

10
05
6

SERVICE TIRES SAFELY

Explosive separation of a tire and rim parts can cause serious injury or death.

Do not attempt to mount a tire unless you have the proper equipment and experience to perform the job.

Always maintain the correct tire pressure. Do not inflate the tires above the recommended pressure. Never weld or heat a wheel and tire assembly. The heat can cause an increase in air pressure resulting in a tire explosion. Welding can structurally weaken or deform the wheel.

When inflating tires, use a clip-on chuck and extension hose long enough to allow you to stand to one side and NOT in front of or over the tire assembly. Use a safety cage if available.

Check wheels for low pressure, cuts, bubbles, damaged rims or missing lug bolts and nuts.

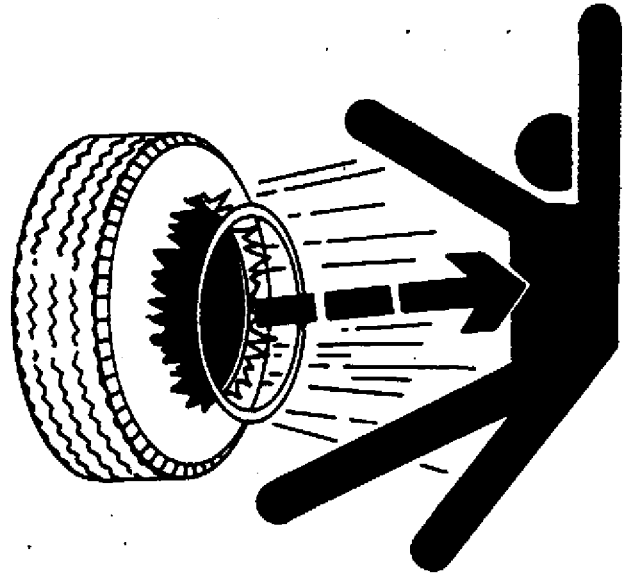

-JUN-23AUG88

TS211

DX,RIM -19-24AUG90

PRACTICE SAFE MAINTENANCE

Understand service procedure before doing work. Keep area clean and dry.

Never lubricate, service, or adjust machine while it is moving. Keep hands, feet, and clothing from power-driven parts. Disengage all power and operate controls to relieve pressure. Lower equipment to the ground. Stop the engine. Remove the key. Allow machine to cool.

Securely support any machine elements that must be raised for service work.

Keep all parts in good condition and properly installed. Fix damage immediately. Replace worn or broken parts. Remove any buildup of grease, oil, or debris.

Disconnect battery ground cable (-) before making adjustments on electrical systems or welding on machine.



-JUN-23AUG88

TS218

DX,SERV -19-03MAR93

ROLLER CHAIN AND PESTICIDE GEAR LUBRICATION

The most effective roller chain lubrication routine varies, depending on the environmental conditions and/or condition of the chain. The goal is to maintain complete freedom at every chain link joint.

Lubricate all planter roller chains with John Deere Multipurpose Spray Lube, TY6350 (or equivalent) at intervals sufficient to maintain free chain movement.

When roller chains remain unused for several days, moisture in the air will accumulate on the chain, causing the chain to rust. This can and will become serious enough in time to cause the chain joints to become stiff, restricting their normal free movement. While very difficult to detect, this stiffness can disturb the smooth rotation of seed meter components and cause a deterioration in performance and seed spacing.

If the planter is not to be used for several days, thoroughly lubricate the chains with John Deere Multipurpose Spray Lube, TY6350, at the beginning of the idle period. If the roller chains have become rusty or stiff during the idle period, lubricate prior to continued usage and operate or "work" the chains sufficiently to ensure all chain joints move freely before normal planter operation is resumed.

Lubricate pesticide drive chain (A) and seed meter drive chain (B) with John Deere Multipurpose Spray Lube, TY6350.

Lubricate pesticide drive gears (C) with John Deere Multipurpose Spray Lube, TY6350. Move the drive disconnect handle (D) back and forth while spraying. This will loosen any paint or dirt buildup and help allow the gears to turn freely. In adverse conditions it may be necessary to lubricate these gears daily.

IMPORTANT: Do not use chain lube or any other heavy petroleum base lubricant that may cause a buildup of dust or dirt in the sprocket or gear teeth.

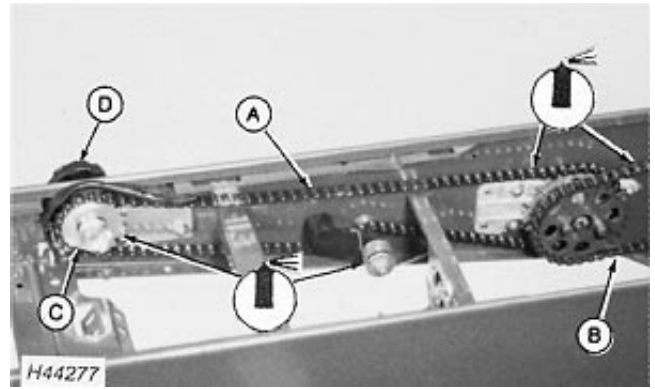

Planting Unit (1993—)

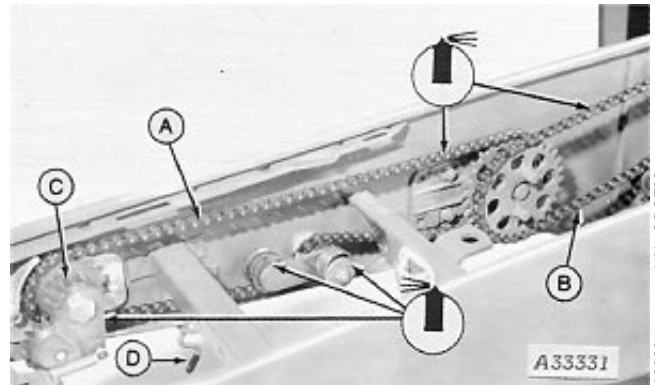

Planting Unit (—1992)

PTO DRIVEN HYDRAULIC PUMP FOR VACUUM METER

At the beginning of each season, replace oil in pump with 10W John Deere TORQ-GARD® Engine oil or equivalent. Fill at (A) to sight gauge.



A34354 -UN-05DEC89

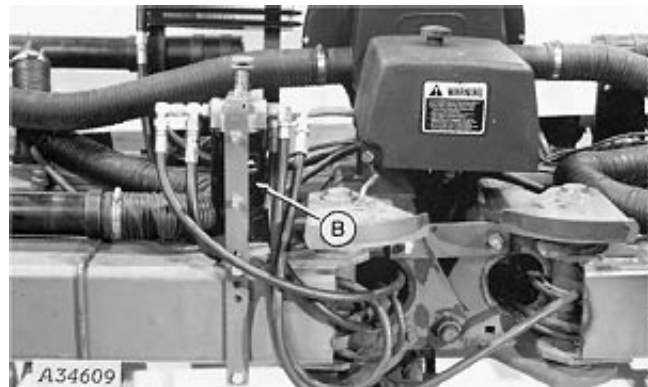

A34609 -UN-06DEC89

TM1366,1020,E -19-09APR94

DRIVE WHEEL

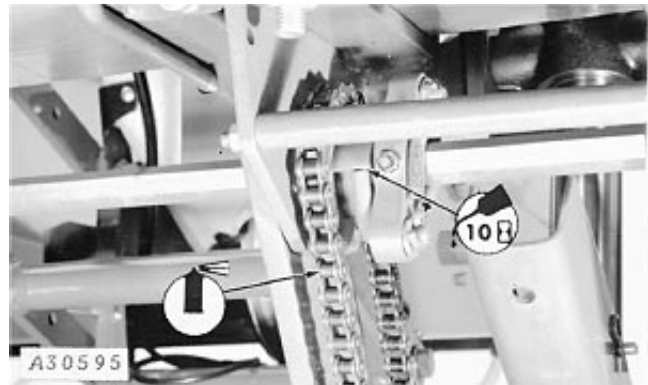

A30595 -UN-12OCT88

TM1366,1020,F -19-09APR94

WHEEL ARMS AND CYLINDER PINS



A29981 -UN-06OCT88

TM1366,1020,G -19-09APR94

GAUGE WHEELS

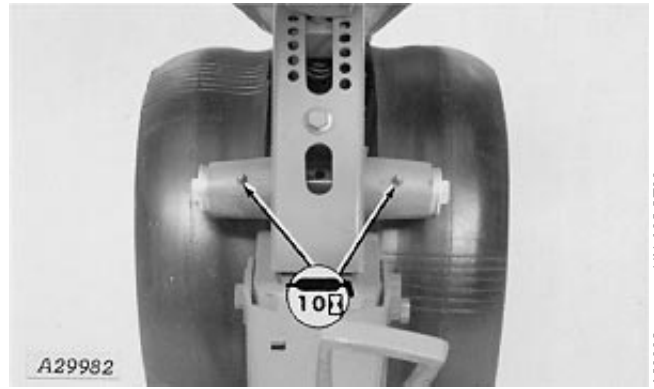

TM1366,1020,H -19-09APR94

A29982 -JUN-06OCT88

10-20-5

TILLAGE SUPPORT BRACKET

A—Lubricate at beginning and end of planting season with John Deere Multi-Purpose Lubricant or an equivalent SAE multi-purpose-type grease

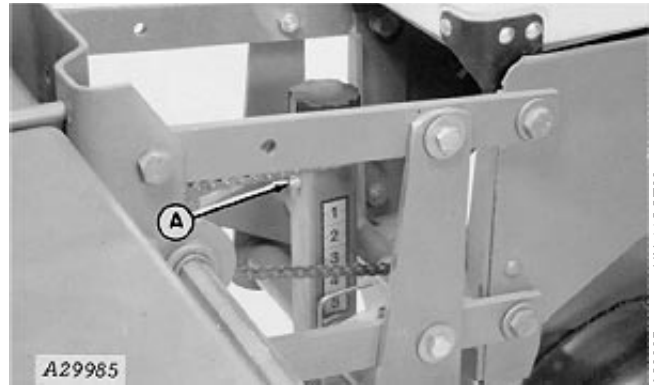

TM1366,1020,I -19-09APR94

A29985 -JUN-11OCT88

HITCH

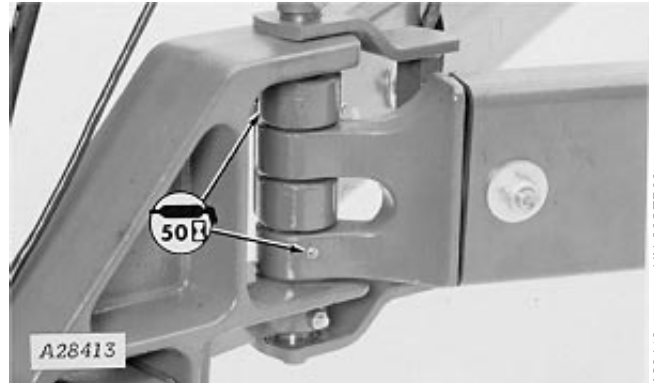

TM1366,1020,J -19-09APR94

A28413 -JUN-26SEP89

DRAWBAR PIN

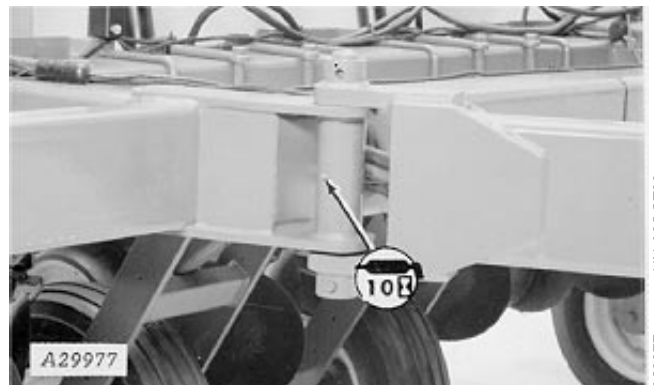

TM1366,1020,K -19-09APR94

A29977 -JUN-06OCT88

HINGE PIN

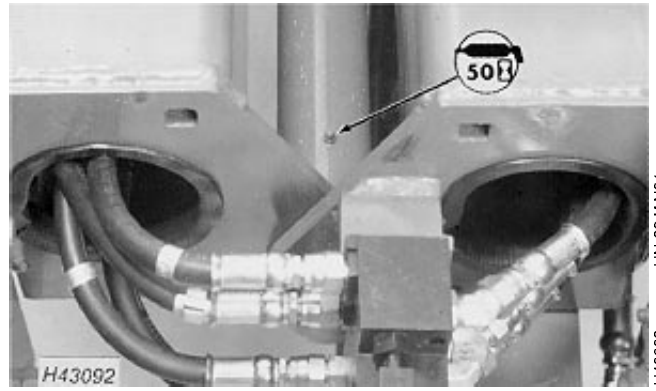

TM1366,1020,L -19-09APR94

H43092
-UN-28JAN91

PIVOT PINS

Pivot Pins (Flex-Fold Illustrated)

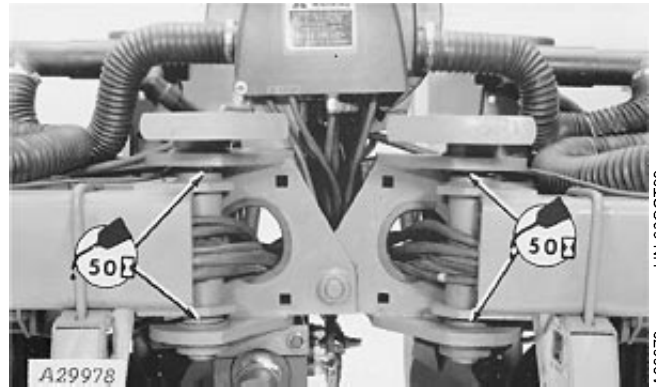

TM1366,1020,M -19-09APR94

A29978
-UN-06OCT88

Pivot Pins (Rigid-Fold Illustrated)

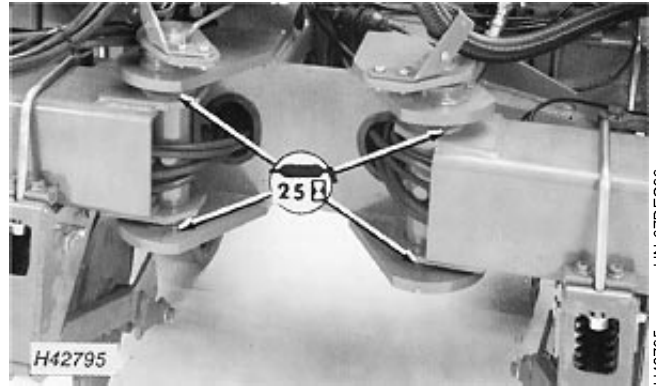

TM1366,1020,N -19-28FEB92

H42795
-UN-07DEC90

SEED TRANSMISSION DRIVE CHAINS

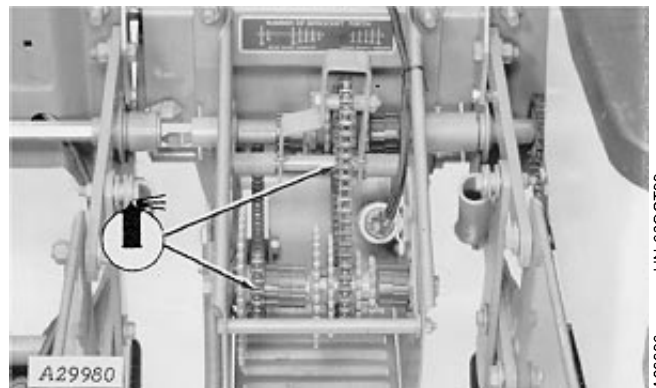

TM1366,1020,O -19-09APR94

A29980
-UN-06OCT88

FRAME MOUNTED COULTER

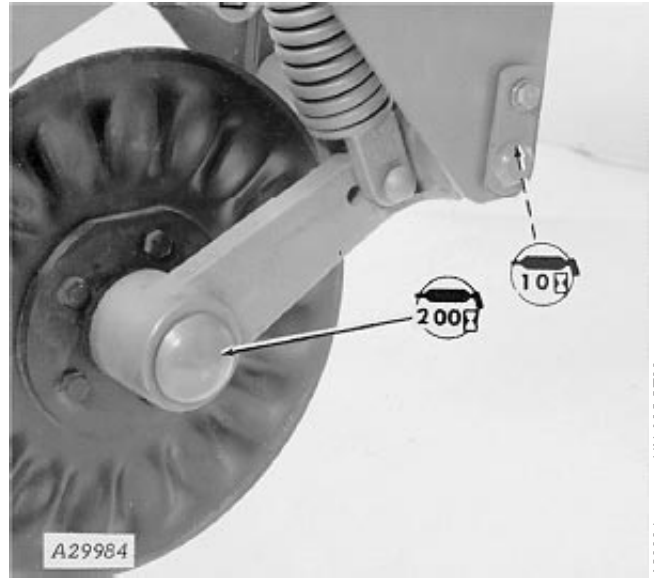

TM1366,1020,P -19-09APR94

10
20
7
A29984 -JUN-06OCT88

SINGLE-DISK FERTILIZER OPENER

NOTE: Grease lower pivot pins (two places) and arm pivot every ten hours. Oil lower spring pivot pins every 50 hours and at the beginning and end of each season. Oil will prevent top of pin from rusting.

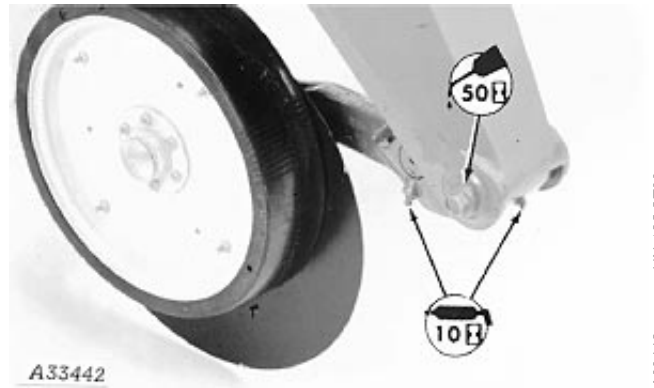

TM1366,1020,Q -19-09APR94

A33442 -JUN-12OCT88

UNIT MOUNTED COULTER

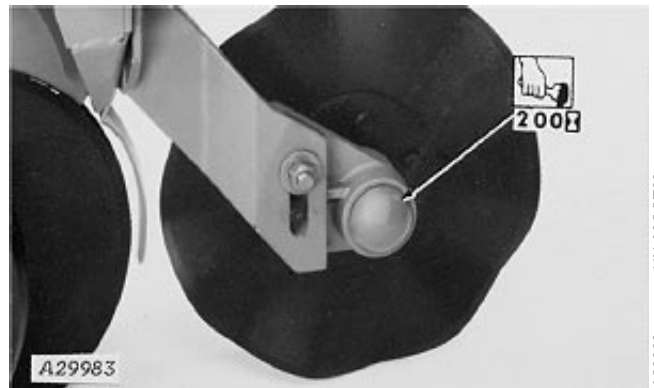

TM1366,1020,R -19-09APR94

A29983 -JUN-06OCT88

FERTILIZER TRANSMISSION

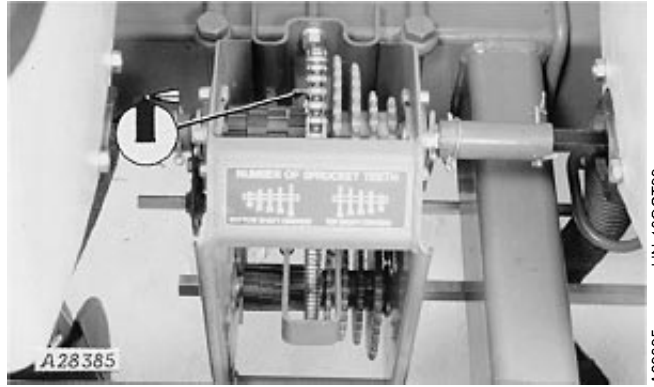

A28385
-JUN-13OCT88

(Dry Fertilizer Attachment Illustrated)

TM1366,1020,S -19-09APR94

FERTILIZER DRIVE CHAIN

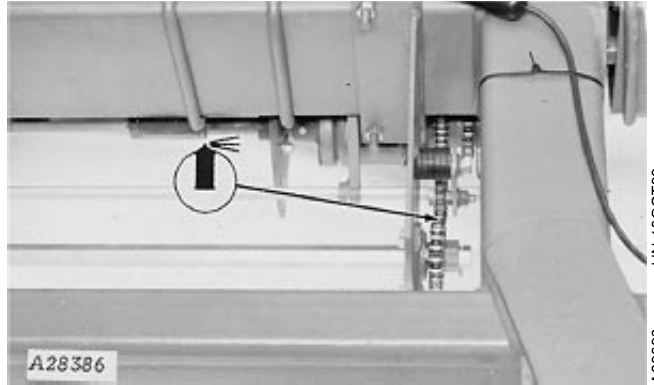

A28386
-JUN-13OCT88

(Right-Hand Side)

TM1366,1020,T -19-09APR94

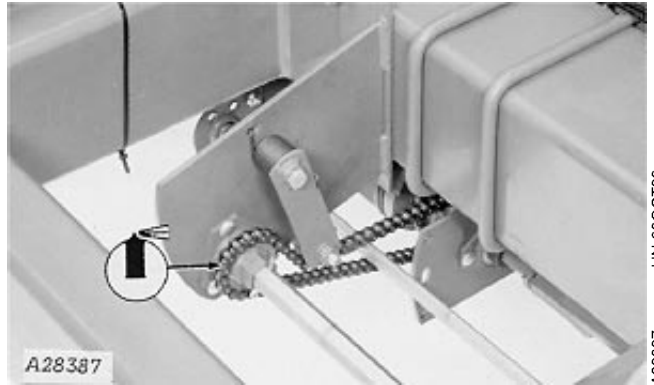

A28387
-JUN-03OCT89

(Left-Hand Side)

TM1366,1020,U -19-09APR94

LIQUID FERTILIZER ATTACHMENT

- A-Lubricate at beginning
- and end of planting
- season with John Deere
- Multi-Purpose
- Lubricant or an
- equivalent SAE
- multi-purpose-type
- grease.

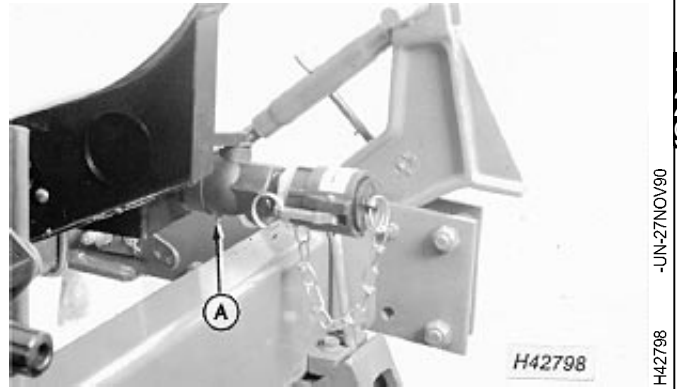

Shut-Off Valves

TM1366,1020,V -19-09APR94

HINGE PIN

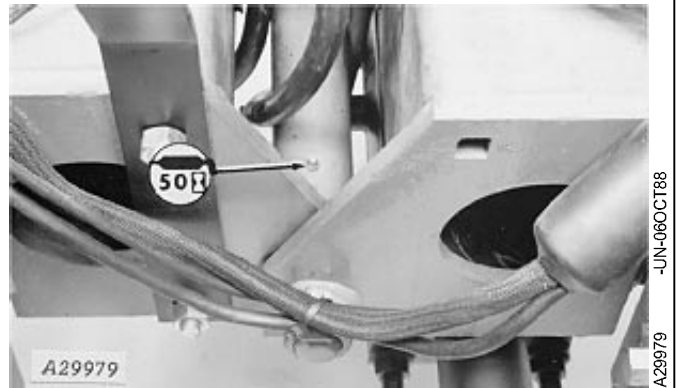

(Flex-Fold) (-402369)

TM1366,1020,W -19-09APR94

12-ROW RIGID-FOLD

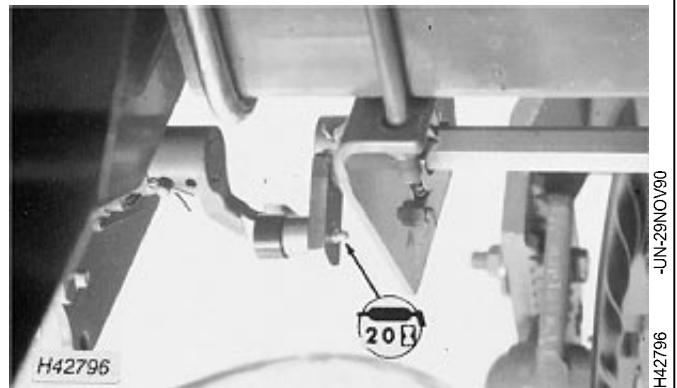

TM1366,1020,X -19-09APR94

16-ROW NARROW AND 24-ROW NARROW

10
20
10

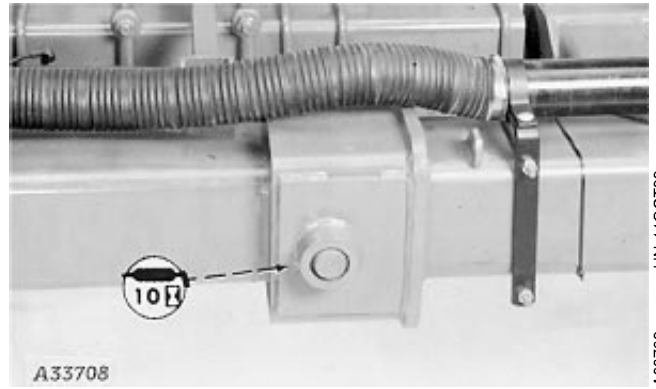

A33708

-JUN-11OCT88
A33708

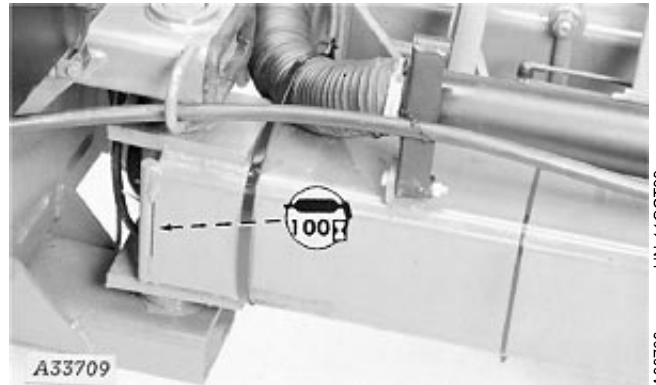

A33709

-JUN-11OCT88
A33709

TM1366,1020,Y -19-28FEB92



Yoke and Shaft

A33710

-JUN-11OCT88
A33710

TM1366,1020,Z -19-28FEB92

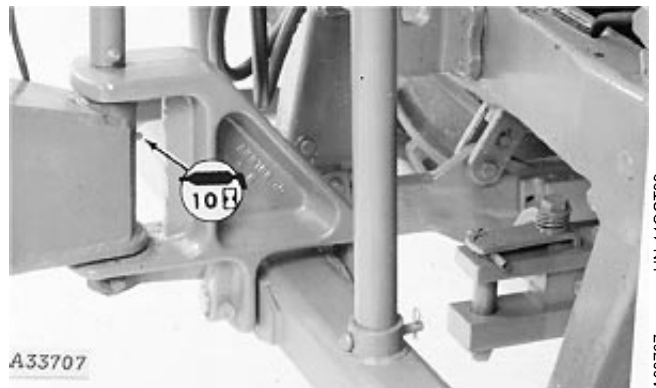

Hitch

A33707

-JUN-11OCT88
A33707

TM1366,1020,A1 -19-28FEB92

Drive

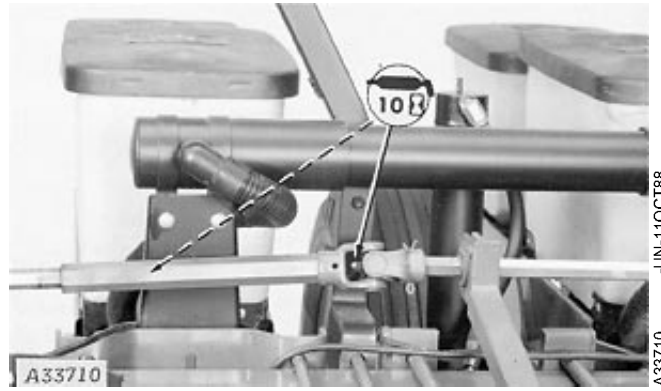

A33710
-JUN-11OCT88

TM1366,1020,A2 -19-28FEB92

Drive Wheel

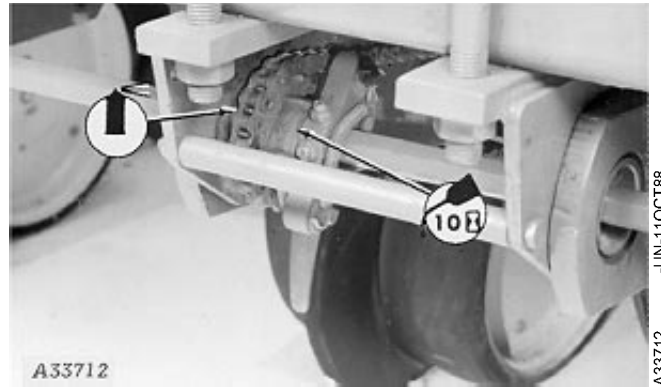

A33712
-JUN-11OCT88

TM1366,1020,A3 -19-28FEB92

Dry Fertilizer Coupler

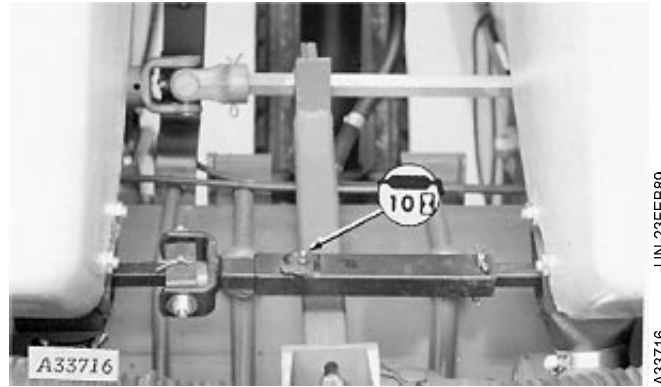

A33716
-JUN-23FEB89

TM1366,1020,A4 -19-28FEB92

Fertilizer Drive Chain (Left-Hand Side)

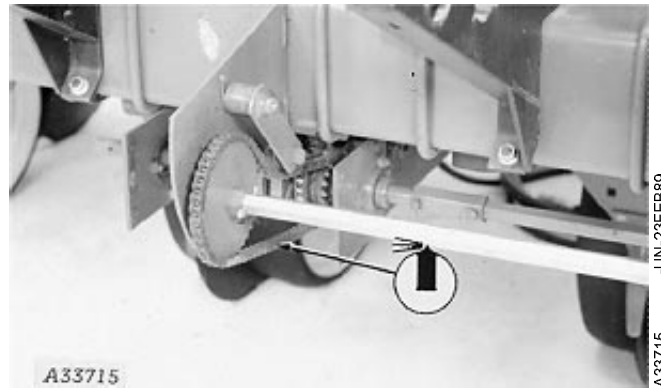

A33715
-JUN-23FEB89

TM1366,1020,A5 -19-28FEB92

COUNTERSHAFT DRIVE COUPLER

10
20
12

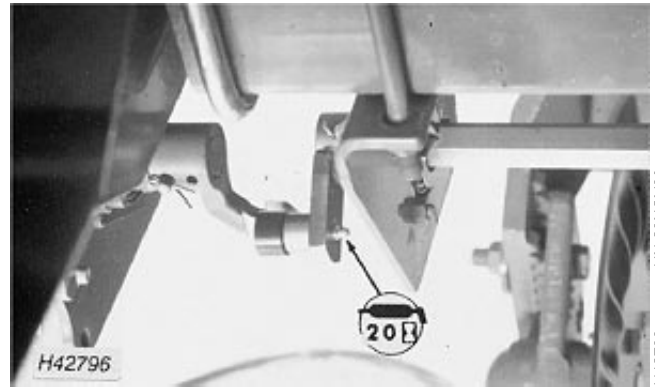

-JUN-29NOV90
H42796

(12-Row Rigid Fold Only)

TM1366,1020,B1 -19-09APR94

ALTERNATIVE LUBRICANTS

Conditions in certain geographical areas may require special lubricants and lubrication practices which do not appear in this manual. If you have any questions, consult your John Deere dealer to obtain the latest information and recommendations.

TM1366,1020,A6 -19-09APR94

SPECIAL LUBRICANTS FOR VACUUM SEED METERS

Seed treatments can cause a deterioration in seed singulation, spacing accuracy and seed flow into the vacuum seed meter. To minimize the effect seed treatments may have on vacuum meter performance, John Deere Talc Lubricant should be used whenever treated seed is being planted.

Spread 1/2 cup of talc over the top of each hopper full of seeds to be planted. Adjust this rate as necessary so all seeds become coated with talc, while avoiding an accumulation of talc settling in the bottom of the seed hopper.

For small seed sizes, seed types with excessive treatment, or for humid planting environments (all commonly associated with cotton or sorghum planting), increasing the rate to one cup per hopper full of seed and mixing thoroughly may be required.

NOTE: Using talc with liquid hopper applied seed treatments which leave a wet coating on the seed is not recommended.

TM1366,1020,A7 -19-09APR94



Download the full PDF manual instantly.

Our customer service e-mail:

aservicemanualpdf@yahoo.com