

# SHOP MANUAL

# **KOMATSU** *ADVANCE* **LOADER** **WA800-3**

MACHINE MODEL

SERIAL NO.

**WA800-3**

**50001 and up**

- This shop manual may contain attachments and optional equipment that are not available in your area. Please consult your local Komatsu distributor for those items you may require.  
Materials and specifications are subject to change without notice.
- WA800-3 mount the SA12V140-1 engine.  
For details of the engine, see the 12V140-1 Series Engine Shop Manual.

# CONTENTS

	No. of page
<b>01 GENERAL .....</b>	<b>01-1</b>
<b>10 STRUCTURE AND FUNCTION .....</b>	<b>10-1</b>
<b>20 TESTING AND ADJUSTING .....</b>	<b>20-1</b>
<b>30 DISASSEMBLY AND ASSEMBLY .....</b>	<b>30-1</b>
<b>40 MAINTENANCE STANDARD .....</b>	<b>40-1</b>
<b>90 OTHERS .....</b>	<b>90-1</b>

# SAFETY

## SAFETY NOTICE

### IMPORTANT SAFETY NOTICE

Proper service and repair is extremely important for safe machine operation. The service and repair techniques recommended by Komatsu and described in this manual are both effective and safe. Some of these techniques require the use of tools specially designed by Komatsu for the specific purpose.

To prevent injury to workers, the symbol  is used to mark safety precautions in this manual. The cautions accompanying these symbols should always be followed carefully. If any dangerous situation arises or may possibly arise, first consider safety, and take the necessary actions to deal with the situation.

### GENERAL PRECAUTIONS

Mistakes in operation are extremely dangerous. Read the Operation and Maintenance Manual carefully BEFORE operating the machine.

1. Before carrying out any greasing or repairs, read all the precautions given on the decals which are fixed to the machine.
2. When carrying out any operation, always wear safety shoes and helmet. Do not wear loose work clothes, or clothes with buttons missing.
  - Always wear safety glasses when hitting parts with a hammer.
  - Always wear safety glasses when grinding parts with a grinder, etc.
3. If welding repairs are needed, always have a trained, experienced welder carry out the work. When carrying out welding work, always wear welding gloves, apron, hand shield, cap and other clothes suited for welding work.
4. When carrying out any operation with two or more workers, always agree on the operating procedure before starting. Always inform your fellow workers before starting any step of the operation. Before starting work, hang UNDER REPAIR signs on the controls in the operator's compartment.
5. Keep all tools in good condition and learn the correct way to use them.

6. Decide a place in the repair workshop to keep tools and removed parts. Always keep the tools and parts in their correct places. Always keep the work area clean and make sure that there is no dirt or oil on the floor. Smoke only in the areas provided for smoking. Never smoke while working.

### PREPARATIONS FOR WORK

7. Before adding oil or making any repairs, park the machine on hard, level ground, and block the wheels or tracks to prevent the machine from moving.
8. Before starting work, lower blade, ripper, bucket or any other work equipment to the ground. If this is not possible, insert the safety pin or use blocks to prevent the work equipment from falling. In addition, be sure to lock all the control levers and hang warning signs on them.
9. When disassembling or assembling, support the machine with blocks, jacks or stands before starting work.
10. Remove all mud and oil from the steps or other places used to get on and off the machine. Always use the handrails, ladders or steps when getting on or off the machine. Never jump on or off the machine. If it is impossible to use the handrails, ladders or steps, use a stand to provide safe footing.

**PRECAUTIONS DURING WORK**

11. When removing the oil filler cap, drain plug or hydraulic pressure measuring plugs, loosen them slowly to prevent the oil from spurting out. Before disconnecting or removing components of the oil, water or air circuits, first remove the pressure completely from the circuit.
12. The water and oil in the circuits are hot when the engine is stopped, so be careful not to get burned.  
Wait for the oil and water to cool before carrying out any work on the oil or water circuits.
13. Before starting work, remove the leads from the battery. Always remove the lead from the negative (-) terminal first.
14. When raising heavy components, use a hoist or crane.  
Check that the wire rope, chains and hooks are free from damage.  
Always use lifting equipment which has ample capacity.  
Install the lifting equipment at the correct places.  
Use a hoist or crane and operate slowly to prevent the component from hitting any other part.  
Do not work with any part still raised by the hoist or crane.
15. When removing covers which are under internal pressure or under pressure from a spring, always leave two bolts in position on opposite sides. Slowly release the pressure, then slowly loosen the bolts to remove.
16. When removing components, be careful not to break or damage the wiring. Damaged wiring may cause electrical fires.
17. When removing piping, stop the fuel or oil from spilling out. If any fuel or oil drips onto the floor, wipe it up immediately. Fuel or oil on the floor can cause you to slip, or can even start fires.
18. As a general rule, do not use gasoline to wash parts. In particular, use only the minimum of gasoline when washing electrical parts.
19. Be sure to assemble all parts again in their original places.  
Replace any damaged parts with new parts.
  - When installing hoses and wires, be sure that they will not be damaged by contact with other parts when the machine is being operated.
20. When installing high pressure hoses, make sure that they are not twisted. Damaged tubes are dangerous, so be extremely careful when installing tubes for high pressure circuits. Also, check that connecting parts are correctly installed.
21. When assembling or installing parts, always use the specified tightening torques. When installing protective parts such as guards, or parts which vibrate violently or rotate at high speed, be particularly careful to check that they are installed correctly.
22. When aligning two holes, never insert your fingers or hand. Be careful not to get your fingers caught in a hole.
23. When measuring hydraulic pressure, check that the measuring tool is correctly assembled before taking any measurements.
24. Take care when removing or installing the tracks of track-type machines.  
When removing the track, the track separates suddenly, so never let anyone stand at either end of the track.

# FOREWORD

## GENERAL

This shop manual has been prepared as an aid to improve the quality of repairs by giving the serviceman an accurate understanding of the product and by showing him the correct way to perform repairs and make judgments. Make sure you understand the contents of this manual and use it to full effect at every opportunity.

This shop manual mainly contains the necessary technical information for operations performed in a service workshop. For ease of understanding, the manual is divided into the following chapters; these chapters are further divided into the each main group of components.

### STRUCTURE AND FUNCTION

This section explains the structure and function of each component. It serves not only to give an understanding of the structure, but also serves as reference material for troubleshooting.

In addition, this section may contain hydraulic circuit diagrams, electric circuit diagrams, and maintenance standards.

### TESTING AND ADJUSTING

This section explains checks to be made before and after performing repairs, as well as adjustments to be made at completion of the checks and repairs.

Troubleshooting charts correlating "Problems" with "Causes" are also included in this section.

### DISASSEMBLY AND ASSEMBLY

This section explains the procedures for removing, installing, disassembling and assembling each component, as well as precautions for them.

### MAINTENANCE STANDARD

This section gives the judgment standards for inspection of disassembled parts.

The contents of this section may be described in STRUCTURE AND FUNCTION.

### OTHERS

This section mainly gives hydraulic circuit diagrams and electric circuit diagrams.

In addition, this section may give the specifications of attachments and options together.

### NOTICE

The specifications contained in this shop manual are subject to change at any time and without any advance notice. Use the specifications given in the book with the latest date.

**HOW TO READ THE SHOP MANUAL**

**VOLUMES**

Shop manuals are issued as a guide to carrying out repairs. They are divided as follows:

- Chassis volume:** Issued for every machine model
- Engine volume:** Issued for each engine series
- Electrical volume:** Each issued as one volume to cover all models
- Attachments volume:** Each issued as one volume to cover all models

These various volumes are designed to avoid duplicating the same information. Therefore, to deal with all repairs for any model, it is necessary that chassis, engine, electrical and attachment volumes be available.

**DISTRIBUTION AND UPDATING**

Any additions, amendments or other changes will be sent to KOMATSU distributors. Get the most up-to-date information before you start any work.

**FILING METHOD**

1. See the page number on the bottom of the page. File the pages in correct order.
2. Following examples show how to read the page number.  
Example 1 (Chassis volume):

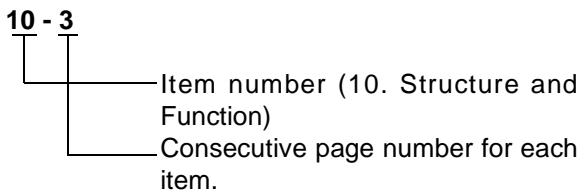

Example 2 (Engine volume):

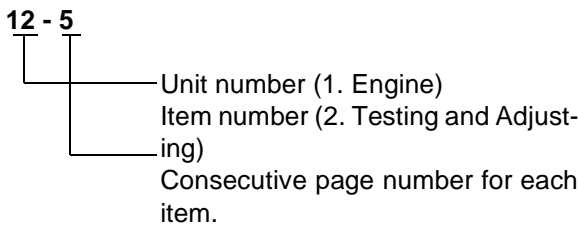

3. Additional pages: Additional pages are indicated by a hyphen (-) and number after the page number. File as in the example.

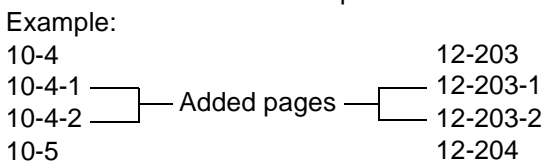

**REVISED EDITION MARK**

When a manual is revised, an edition mark ((1)(2)(3)....) is recorded on the bottom of the pages.

**REVISIONS**

Revised pages are shown in the LIST OF REVISED PAGES next to the CONTENTS page.

**SYMBOLS**

So that the shop manual can be of ample practical use, important safety and quality portions are marked with the following symbols.

Symbol	Item	Remarks
	Safety	Special safety precautions are necessary when performing the work.
	Caution	Special technical precautions or other precautions for preserving standards are necessary when performing the work.
	Weight	Weight of parts of systems. Caution necessary when selecting hoisting wire, or when working posture is important, etc.
	Tightening torque	Places that require special attention for the tightening torque during assembly.
	Coat	Places to be coated with adhesives and lubricants, etc.
	Oil, water	Places where oil, water or fuel must be added, and the capacity.
	Drain	Places where oil or water must be drained, and quantity to be drained.

HOISTING INSTRUCTIONS

HOISTING

**⚠** Heavy parts (25 kg or more) must be lifted with a hoist, etc. In the **DISASSEMBLY AND ASSEMBLY** section, every part weighing 25 kg or more is indicated clearly with the symbol 

- If a part cannot be smoothly removed from the machine by hoisting, the following checks should be made:
  - 1) Check for removal of all bolts fastening the part to the relative parts.
  - 2) Check for existence of another part causing interference with the part to be removed.

WIRE ROPES

- 1) Use adequate ropes depending on the weight of parts to be hoisted, referring to the table below:

Wire ropes  
(Standard "Z" or "S" twist ropes  
without galvanizing)

Rope diameter	Allowable load		
	mm	kN	tons
10	9.8	1.0	
11.5	13.7	1.4	
12.5	15.7	1.6	
14	21.6	2.2	
16	27.5	2.8	
18	35.3	3.6	
20	43.1	4.4	
22.4	54.9	5.6	
30	98.1	10.0	
40	176.5	18.0	
50	274.6	28.0	
60	392.2	40.0	

- ★ The allowable load value is estimated to be one-sixth or one-seventh of the breaking strength of the rope used.
- 2) Sling wire ropes from the middle portion of the hook.

Slinging near the edge of the hook may cause the rope to slip off the hook during hoisting, and a serious accident can result. Hooks have maximum strength at the middle portion.

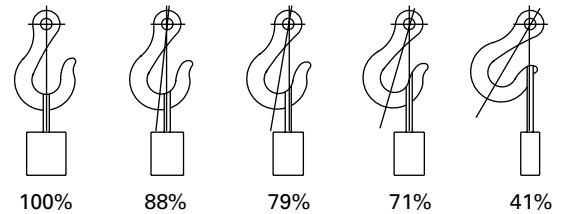

SAD00479

- 3) Do not sling a heavy load with one rope alone, but sling with two or more ropes symmetrically wound onto the load.

**⚠** Slinging with one rope may cause turning of the load during hoisting, untwisting of the rope, or slipping of the rope from its original winding position on the load, which can result in a dangerous accident.

- 4) Do not sling a heavy load with ropes forming a wide hanging angle from the hook.

When hoisting a load with two or more ropes, the force subjected to each rope will increase with the hanging angles. The table below shows the variation of allowable load kN {kg} when hoisting is made with two ropes, each of which is allowed to sling up to 9.8 kN {1000 kg} vertically, at various hanging angles.

When two ropes sling a load vertically, up to 19.6 kN {2000 kg} of total weight can be suspended. This weight becomes 9.8 kN {1000 kg} when two ropes make a 120° hanging angle. On the other hand, two ropes are subjected to an excessive force as large as 39.2 kN {4000 kg} if they sling a 19.6 kN {2000 kg} load at a lifting angle of 150°.

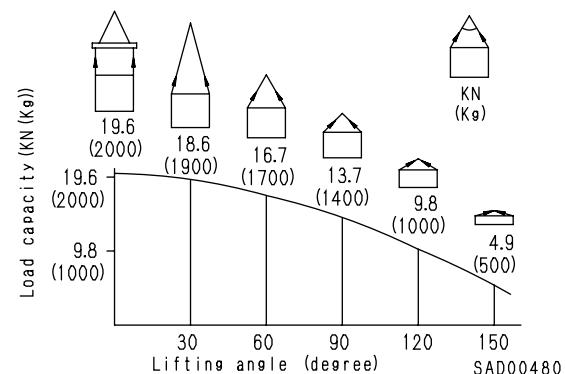

SAD00480

## METHOD OF DISASSEMBLING, CONNECTING PUSH-PULL TYPE COUPLER

**⚠** Before carrying out the following work, release the residual pressure from the hydraulic tank. For details, see TESTING AND ADJUSTING, Releasing residual pressure from hydraulic tank.

**⚠** Even if the residual pressure is released from the hydraulic tank, some hydraulic oil flows out when the hose is disconnected. Accordingly, prepare an oil receiving container.

**Disconnection**

- 1) Release the residual pressure from the hydraulic tank. For details, see TESTING AND ADJUSTING, Releasing residual pressure from hydraulic tank.
- 2) Hold adapter (1) and push hose joint (2) into mating adapter (3). (See Fig. 1)
  - ★ The adapter can be pushed in about 3.5 mm.
  - ★ Do not hold rubber cap portion (4).
- 3) After hose joint (2) is pushed into adapter (3), press rubber cap portion (4) against (3) until it clicks. (See Fig. 2)
- 4) Hold hose adapter (1) or hose (5) and pull it out. (See Fig. 3)
  - ★ Since some hydraulic oil flows out, prepare an oil receiving container.

**Connection**

- 1) Hold hose adapter (1) or hose (5) and insert it in mating adapter (3), aligning them with each other. (See Fig. 4)
  - ★ Do not hold rubber cap portion (4).
- 2) After inserting the hose in the mating adapter perfectly, pull it back to check its connecting condition. (See Fig. 5)
  - ★ When the hose is pulled back, the rubber cap portion moves toward the hose about 3.5 mm. This does not indicate abnormality, however.

Type 1

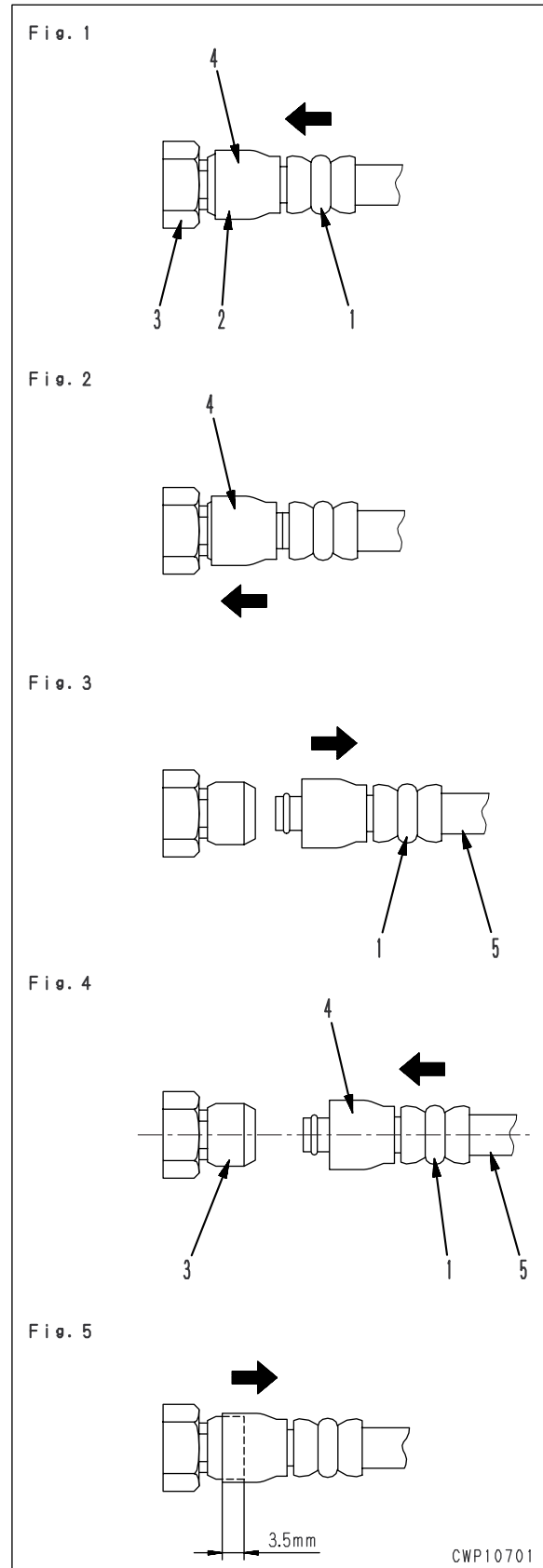

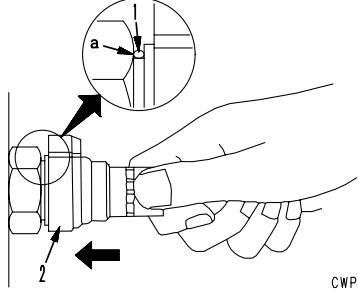
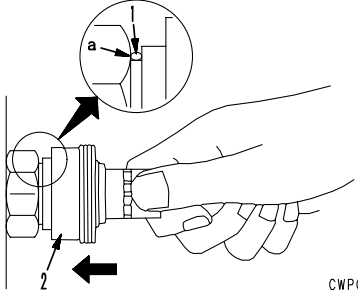
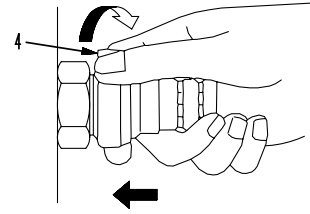
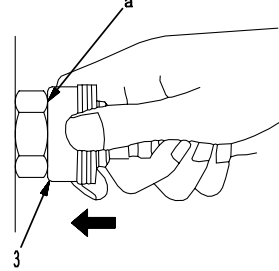
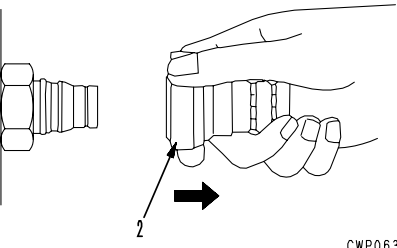
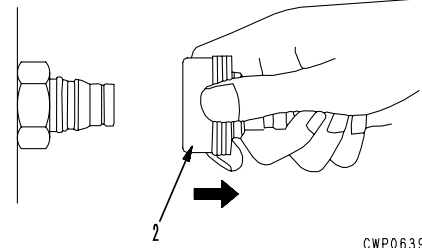
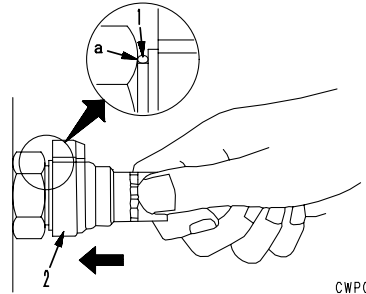
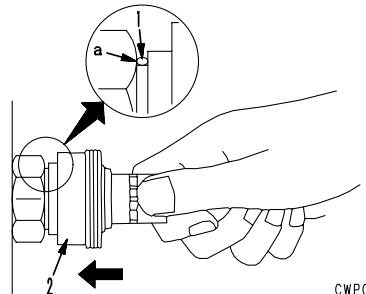

	Type 2	Type 3
Disassembly	<p>1) Hold the mouthpiece of the tightening portion and push body (2) in straight until sliding prevention ring (1) contacts contact surface a of the hexagonal portion at the male end.</p>  <p style="text-align: right;">CWP06392</p>	<p>1) Hold the mouthpiece of the tightening portion and push body (2) in straight until sliding prevention ring (1) contacts contact surface a of the hexagonal portion at the male end.</p>  <p style="text-align: right;">CWP06391</p>
	<p>2) Hold in the condition in Step 1), and turn lever (4) to the right (clockwise).</p>  <p style="text-align: right;">CWP06394</p>	<p>2) Hold in the condition in Step 1), and push until cover (3) contacts contact surface a of the hexagonal portion at the male end.</p>  <p style="text-align: right;">CWP06393</p>
	<p>3) Hold in the condition in Steps 1) and 2), and pull out whole body (2) to disconnect it.</p>  <p style="text-align: right;">CWP06396</p>	<p>3) Hold in the condition in Steps 1) and 2), and pull out whole body (2) to disconnect it.</p>  <p style="text-align: right;">CWP06395</p>
Connection	<ul style="list-style-type: none"> <li>Hold the mouthpiece of the tightening portion and push body (2) in straight until sliding prevention ring (1) contacts contact surface a of the hexagonal portion at the male end to connect it.</li> </ul>  <p style="text-align: right;">CWP06392</p>	<ul style="list-style-type: none"> <li>Hold the mouthpiece of the tightening portion and push body (2) in straight until sliding prevention ring (1) contacts contact surface a of the hexagonal portion at the male end to connect it.</li> </ul>  <p style="text-align: right;">CWP06391</p>

## COATING MATERIALS

- ★ The recommended coating materials such as adhesives, gasket sealants and greases used for disassembly and assembly are listed below.
- ★ For coating materials not listed below, use the equivalent of products shown in this list.

Category	Komatsu code	Part No.	Q'ty	Container	Main applications, features
Adhesives	LT-1A	790-129-9030	150 g	Tube	<ul style="list-style-type: none"> <li>• Used to prevent rubber gaskets, rubber cushions, and cock plug from coming out.</li> </ul>
	LT-1B	790-129-9050	20 g (2 pcs.)	Polyethylene container	<ul style="list-style-type: none"> <li>• Used in places requiring an immediately effective, strong adhesive. Used for plastics (except polyethylene, polypropylene, tetrafluoroethylene and vinyl chloride), rubber, metal and non-metal.</li> </ul>
	LT-2	09940-00030	50 g	Polyethylene container	<ul style="list-style-type: none"> <li>• Features: Resistance to heat and chemicals</li> <li>• Used for anti-loosening and sealant purpose for bolts and plugs.</li> </ul>
	LT-3	790-129-9060 (Set of adhesive and hardening agent)	Adhesive: 1 kg Hardening agent: 500 g	Can	<ul style="list-style-type: none"> <li>• Used as adhesive or sealant for metal, glass and plastic.</li> </ul>
	LT-4	790-129-9040	250 g	Polyethylene container	<ul style="list-style-type: none"> <li>• Used as sealant for machined holes.</li> </ul>
	Holtz MH 705	790-126-9120	75 g	Tube	<ul style="list-style-type: none"> <li>• Used as heat-resisting sealant for repairing engine.</li> </ul>
	Three bond 1735	790-129-9140	50 g	Polyethylene container	<ul style="list-style-type: none"> <li>• Quick hardening type adhesive</li> <li>• Cure time: within 5 sec. to 3 min.</li> <li>• Used mainly for adhesion of metals, rubbers, plastics and woods.</li> </ul>
	Aron-alpha 201	790-129-9130	2 g	Polyethylene container	<ul style="list-style-type: none"> <li>• Quick hardening type adhesive</li> <li>• Quick cure type (max. strength after 30 minutes)</li> <li>• Used mainly for adhesion of rubbers, plastics and metals.</li> </ul>
	Loctite 648-50	79A-129-9110	50 cc	Polyethylene container	<ul style="list-style-type: none"> <li>• Resistance to heat, chemicals</li> <li>• Used at joint portions subject to high temperatures.</li> </ul>
Gasket sealant	LG-1	790-129-9010	200 g	Tube	<ul style="list-style-type: none"> <li>• Used as adhesive or sealant for gaskets and packing of power train case, etc.</li> </ul>
	LG-5	790-129-9080	1 kg	Can	<ul style="list-style-type: none"> <li>• Used as sealant for various threads, pipe joints, flanges.</li> <li>• Used as sealant for tapered plugs, elbows, nipples of hydraulic piping.</li> </ul>
	LG-6	790-129-9020	200 g	Tube	<ul style="list-style-type: none"> <li>• Features: Silicon based, resistance to heat, cold</li> <li>• Used as sealant for flange surface, tread.</li> <li>• Used as sealant for oil pan, final drive case, etc.</li> </ul>
	LG-7	790-129-9070	1 g	Tube	<ul style="list-style-type: none"> <li>• Features: Silicon based, quick hardening type</li> <li>• Used as sealant for flywheel housing, intake manifold, oil an, thermostat housing, etc.</li> </ul>
	Three bond 1211	790-129-9090	100 g	Tube	<ul style="list-style-type: none"> <li>• Used as heat-resisting sealant for repairing engine.</li> </ul>
	Three bond 1207B	419-15-18131	100 g	Tube	<ul style="list-style-type: none"> <li>• Features: Silicone type, heat resistant, vibration resistant, and impact resistant sealing material</li> <li>• Used as sealing material for transfer case</li> </ul>

Category	Komatsu code	Part No.	Q'ty	Container	Main applications, featuresr
Molybdenum disulphide lubricant	LM-G	09940-00051	60 g	Can	<ul style="list-style-type: none"> <li>Used as lubricant for sliding portion (to prevent from squeaking).</li> </ul>
	LM-P	09940-00040	200 g	Tube	<ul style="list-style-type: none"> <li>Used to prevent seizure or scuffing of the thread when press fitting or shrink fitting.</li> <li>Used as lubricant for linkage, bearings, etc.</li> </ul>
Grease	G2-LI	SYG2-400LI SYG2-350LI SYG2-400LI-A SYG2-160LI SYGA-160CNLI	Various	Various	<ul style="list-style-type: none"> <li>General purpose type</li> </ul>
	G2-CA	SYG2-400CA SYG2-350CA SYG2-400CA-A SYG2-160CA SYGA-160CNCA	Various	Various	<ul style="list-style-type: none"> <li>Used for normal temperature, light load bearing at places in contact with water or steam.</li> </ul>
	Molybdenum disulphide grease LM-G (G2-M)	SYG2-400M SYG2-400M-A SYGA-16CNM	400 g × 10 400 g × 20 16 kg	Bellows type Bellows type Can	<ul style="list-style-type: none"> <li>Used for heavy load portion</li> </ul>
	Hyper White Grease G2-T G0-T (*) *: For use in cold district	SYG2-400T-A SYG2-16CNT SYG0-400T-A (*) SYG0-16CNT (*)	400 g 16 kg	Bellows type Can	<ul style="list-style-type: none"> <li>Seizure resistance and heat resistance higher than molybdenum disulfide grease</li> <li>Since this grease is white, it does not stand out against machine body.</li> </ul>
	Biogrease G2B G2-BT (*) *: For high temperature and large load	SYG2-400B SYGA-16CNCB SYG2-400BT (*) SYGA-16CNBT (*)	400 g 16 kg	Bellows type Can	<ul style="list-style-type: none"> <li>Since this grease is decomposed by bacteria in short period, it has less effects on microorganisms, animals, and plants.</li> </ul>
Primer	SUNSTAR PAINT PRIMER 580 SUPER	417-926-3910	20 ml	Glass container	Adhesive for cab glass <ul style="list-style-type: none"> <li>Used as primer for cab side (Using limit: 4 months)</li> </ul>
	SUNSTAR GLASS PRIMER 580 SUPER		20 ml	Glass container	
Adhesive	SUNSTAR PENGUINE SEAL 580 SUPER "S" or "W"		320 ml	Polyethylene container	
	Sika Japan, Sikaflex 256HV	20Y-54-39850	310 ml	Polyethylene container	
Caulking material	SUNSTAR PENGUINE SEAL No. 2505	417-926-3920	320 ml	Polyethylene container	
	SEKISUI SILICONE SEALANT	20Y-54-55130	333 ml	Polyethylene container	<ul style="list-style-type: none"> <li>Used to seal front window. (Using limit: 6 months)</li> </ul>

# STANDARD TIGHTENING TORQUE

## STANDARD TIGHTENING TORQUE TABLE (WHEN USING TORQUE WRENCH)

★ In the case of metric nuts and bolts for which there is no special instruction, tighten to the torque given in the table below.

Thread diameter of bolt	Width across flats	Tightening torque	
		Nm	kgm
mm	mm		
6	10	11.8 – 14.7	1.2 – 1.5
8	13	27 – 34	2.8 – 3.5
10	17	59 – 74	6 – 7.5
12	19	98 – 123	10 – 12.5
14	22	153 – 190	15.5 – 19.5
16	24	235 – 285	23.5 – 29.5
18	27	320 – 400	33 – 41
20	30	455 – 565	46.5 – 58
22	32	610 – 765	62.5 – 78
24	36	785 – 980	80 – 100
27	41	1150 – 1440	118 – 147
30	46	1520 – 1910	155 – 195
33	50	1960 – 2450	200 – 250
36	55	2450 – 3040	250 – 310
39	60	2890 – 3630	295 – 370



CDL00372

Thread diameter of bolt	Width across flats	Tightening torque	
		Nm	kgm
mm	mm		
6	10	5.9 – 9.8	0.6 – 1.0
8	13	13.7 – 23.5	1.4 – 2.4
10	14	34.3 – 46.1	3.5 – 4.7
12	27	74.5 – 90.2	7.6 – 9.2



CDL00373

## TABLE OF TIGHTENING TORQUES FOR FLARED NUTS

★ In the case of flared nuts for which there is no special instruction, tighten to the torque given in the table below.

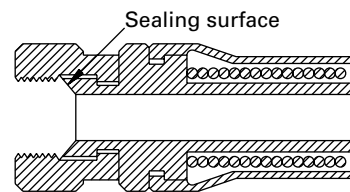

SAD00483

Thread diameter	Width across flat	Tightening torque	
		Nm	kgm
mm	mm		
14	19	24.5 ± 4.9	2.5 ± 0.5
18	24	49 ± 19.6	5 ± 2
22	27	78.5 ± 19.6	8 ± 2
24	32	137.3 ± 29.4	14 ± 3
30	36	176.5 ± 29.4	18 ± 3
33	41	196.1 ± 49	20 ± 5
36	46	245.2 ± 49	25 ± 5
42	55	294.2 ± 49	30 ± 5

**TABLE OF TIGHTENING TORQUES FOR SPLIT FLANGE BOLTS**

★ In the case of split flange bolts for which there is no special instruction, tighten to the torque given in the table below.

Thread diameter	Width across flat	Tightening torque	
		Nm	kgm
mm	mm		
10	14	59 – 74	6 – 7.5
12	17	98 – 123	10 – 12.5
16	22	235 – 285	23.5 – 29.5

**TABLE OF TIGHTENING TORQUES FOR O-RING BOSS PIPING JOINTS**

★ Unless there are special instructions, tighten the O-ring boss piping joints to the torque below.

Norminal No.	Thread diameter	Width across flat	Tightening torque (Nm {kgm})	
	mm	mm	Range	Target
02	14	Varies depending on type of connector.	35 – 63 {3.5 – 6.5}	44 {4.5}
03, 04	20		84 – 132 {8.5 – 13.5}	103 {10.5}
05, 06	24		128 – 186 {13.0 – 19.0}	157 {16.0}
10, 12	33		363 – 480 {37.0 – 49.0}	422 {43.0}
14	42		746 – 1010 {76.0 – 103}	883 {90.0}

**TABLE OF TIGHTENING TORQUES FOR O-RING BOSS PLUGS**

★ Unless there are special instructions, tighten the O-ring boss plugs to the torque below.

Norminal No.	Thread diameter	Width across flat	Tightening torque (Nm {kgm})	
	mm	mm	Range	Target
08	08	14	5.88 – 8.82 {0.6 – 0.9}	7.35 {0.75}
10	10	17	9.8 – 12.74 {1.0 – 1.3}	11.27 {1.15}
12	12	19	14.7 – 19.6 {1.5 – 2.0}	17.64 {1.8}
14	14	22	19.6 – 24.5 {2.0 – 2.5}	22.54 {2.3}
16	16	24	24.5 – 34.3 {2.5 – 3.5}	29.4 {3.0}
18	18	27	34.3 – 44.1 {3.5 – 4.5}	39.2 {4.0}
20	20	30	44.1 – 53.9 {4.5 – 5.5}	49.0 {5.0}
24	24	32	58.8 – 78.4 {6.0 – 8.0}	68.6 {7.0}
30	30	32	93.1 – 122.5 {9.5 – 12.5}	107.8 {11.0}
33	33	—	107.8 – 147.0 {11.0 – 15.0}	124.4 {13.0}
36	36	36	127.4 – 176.4 {13.0 – 18.0}	151.9 {15.5}
42	42	—	181.3 – 240.1 {18.5 – 24.5}	210.7 {21.5}
52	52	—	274.4 – 367.5 {28.0 – 37.5}	323.4 {33.0}

**TIGHTENING TORQUE FOR 102 ENGINE SERIES****1) BOLT AND NUTS**

Use these torques for bolts and nuts (unit: mm) of Cummins Engine.

Thread diameter	Tightening torque	
	Nm	kgm
6	10 ± 2	1.02 ± 0.20
8	24 ± 4	2.45 ± 0.41
10	43 ± 6	4.38 ± 0.61
12	77 ± 12	7.85 ± 1.22

**2) EYE JOINTS**

Use these torques for eye joints (unit: mm) of Cummins Engine.

Thread diameter	Tightening torque	
	Nm	kgm
6	8 ± 2	0.81 ± 0.20
8	10 ± 2	1.02 ± 0.20
10	12 ± 2	1.22 ± 0.20
12	24 ± 4	2.45 ± 0.41
14	36 ± 5	3.67 ± 0.51

**3) TAPERED SCREWS**

Use these torques for tapered screws (unit: inch) of Cummins Engine.

Thread diameter	Tightening torque	
	Nm	kgm
1 / 16	3 ± 1	0.31 ± 0.10
1 / 8	8 ± 2	0.81 ± 0.20
1 / 4	12 ± 2	1.22 ± 0.20
3 / 8	15 ± 2	1.53 ± 0.41
1 / 2	24 ± 4	2.45 ± 0.41
3 / 4	36 ± 5	3.67 ± 0.51
1	60 ± 9	6.12 ± 0.92

**TIGHTENING TORQUE TABLE FOR HOSES (TAPER SEAL TYPE AND FACE SEAL TYPE)**

★ Tighten the hoses (taper seal type and face seal type) to the following torque, unless otherwise specified.

★ Apply the following torque when the threads are coated (wet) with engine oil.

Nominal size of hose	Width across flats	Tightening torque (Nm {kgm})		Taper seal type Thread size (mm)	Face seal type	
		Range	Target		Nominal thread size - Threads per inch, Thread series	Root diameter (mm) (Reference)
02	19	34 - 63 {3.5 - 6.5}	44 {4.5}	14	$\frac{9}{16}$ - 18UNF	14.3
03	22	54 - 93 {5.5 - 9.5}	74 {4.5}	-	$\frac{11}{16}$ - 16UN	17.5
	24	59 - 98 {6.0 - 10.0}	78 {8.0}	18	-	-
04	27	84 - 132 {8.5 - 13.5}	103 {10.5}	22	$\frac{13}{16}$ - 16UN	20.7
05	32	128 - 186 {13.0 - 19.0}	157 {16.0}	24	1 - 14UNS	25.4
06	36	177 - 245 {18.0 - 25.0}	216 {22.0}	30	$1\frac{3}{16}$ - 12UNF	30.3
(10)	41	177 - 245 {18.0 - 25.0}	216 {22.0}	33	-	-
(12)	46	197 - 294 {20.0 - 30.0}	245 {25.0}	36	-	-
(14)	55	246 - 343 {25.0 - 35.0}	294 {30.0}	42	-	-

**ELECTRIC WIRE CODE**

In the wiring diagrams, various colors and symbols are employed to indicate the thickness of wires. This wire code table will help you understand WIRING DIAGRAMS.  
 Example: 5WB indicates a cable having a nominal number 5 and white coating with black stripe.

**CLASSIFICATION BY THICKNESS**

Nominal number	Copper wire			Cable O.D. (mm)	Current rating (A)	Applicable circuit
	Number of strands	Dia. of strands (mm <sup>2</sup> )	Cross section (mm <sup>2</sup> )			
0.85	11	0.32	0.88	2.4	12	Starting, lighting, signal etc.
2	26	0.32	2.09	3.1	20	Lighting, signal etc.
5	65	0.32	5.23	4.6	37	Charging and signal
15	84	0.45	13.36	7.0	59	Starting (Glow plug)
40	85	0.80	42.73	11.4	135	Starting
60	127	0.80	63.84	13.6	178	Starting
100	217	0.80	109.1	17.6	230	Starting

**CLASSIFICATION BY COLOR AND CODE**

Priority	Classification	Circuits							
		Charging	Ground	Starting	Lighting	Instrument	Signal	Other	
1	Primary	Code	W	B	B	R	Y	G	L
		Color	White	Black	Black	Red	Yellow	Green	Blue
2	Auxiliary	Code	WR	—	BW	RW	YR	GW	LW
		Color	White & Red	—	White & Black	Red & White	Yellow & Red	Green & White	Blue & White
3		Code	WB	—	BY	RB	YB	GR	LR
		Color	White & Black	—	Black & Yellow	Red & Black	Yellow & Black	Green & Red	Blue & Yellow
4		Code	WL	—	BR	RY	YG	GY	LY
		Color	White & Blue	—	Black & Red	Red & Yellow	Yellow & Green	Green & Yellow	Blue & Yellow
5		Code	WG	—	—	RG	YL	GB	LB
		Color	White & Green	—	—	Red & Green	Yellow & Blue	Green & Black	Blue & Black
6		Code	—	—	—	RL	YW	GL	—
		Color	—	—	—	Red & Blue	Yellow & White	Green & Blue	—

# CONVERSION TABLE

## METHOD OF USING THE CONVERSION TABLE

The Conversion Table in this section is provided to enable simple conversion of figures. For details of the method of using the Conversion Table, see the example given below.

### EXAMPLE

- Method of using the Conversion Table to convert from millimeters to inches
1. Convert 55 mm into inches.
    - (1) Locate the number 50 in the vertical column at the left side, take this as (A), then draw a horizontal line from (A).
    - (2) Locate the number 5 in the row across the top, take this as (B), then draw a perpendicular line down from (B).
    - (3) Take the point where the two lines cross as (C). This point (C) gives the value when converting from millimeters to inches. Therefore, 55 mm = 2.165 inches.
  2. Convert 550 mm into inches.
    - (1) The number 550 does not appear in the table, so divide by 10 (move the decimal point one place to the left) to convert it to 55 mm.
    - (2) Carry out the same procedure as above to convert 55 mm to 2.165 inches.
    - (3) The original value (550 mm) was divided by 10, so multiply 2.165 inches by 10 (move the decimal point one place to the right) to return to the original value. This gives 550 mm = 21.65 inches.

1 mm = 0.03937 in

	0	1	2	3	4	5	6	7	8	9
0	0	0.039	0.079	0.118	0.157	0.197	0.236	0.276	0.315	0.354
10	0.394	0.433	0.472	0.512	0.551	0.591	0.630	0.669	0.709	0.748
20	0.787	0.827	0.866	0.906	0.945	0.984	1.024	1.063	1.102	1.142
30	1.181	1.220	1.260	1.299	1.339	1.378	1.417	1.457	1.496	1.536
40	1.575	1.614	1.654	1.693	1.732	1.772	1.811	1.850	1.890	1.929
(A) 50	1.969	2.008	2.047	2.087	2.126	2.165	2.205	2.244	2.283	2.323
60	2.362	2.402	2.441	2.480	2.520	2.559	2.598	2.638	2.677	2.717
70	2.756	2.795	2.835	2.874	2.913	2.953	2.992	3.032	3.071	3.110
80	3.150	3.189	3.228	3.268	3.307	3.346	3.386	3.425	3.465	3.504
90	3.543	3.583	3.622	3.661	3.701	3.740	3.780	3.819	3.858	3.898



---

# **01 GENERAL**

---

General assembly drawing .....	01-2
Specifications .....	01-3
Weight table .....	01-6
List of lubricant and water .....	01-8

GENERAL ASSEMBLY DRAWING

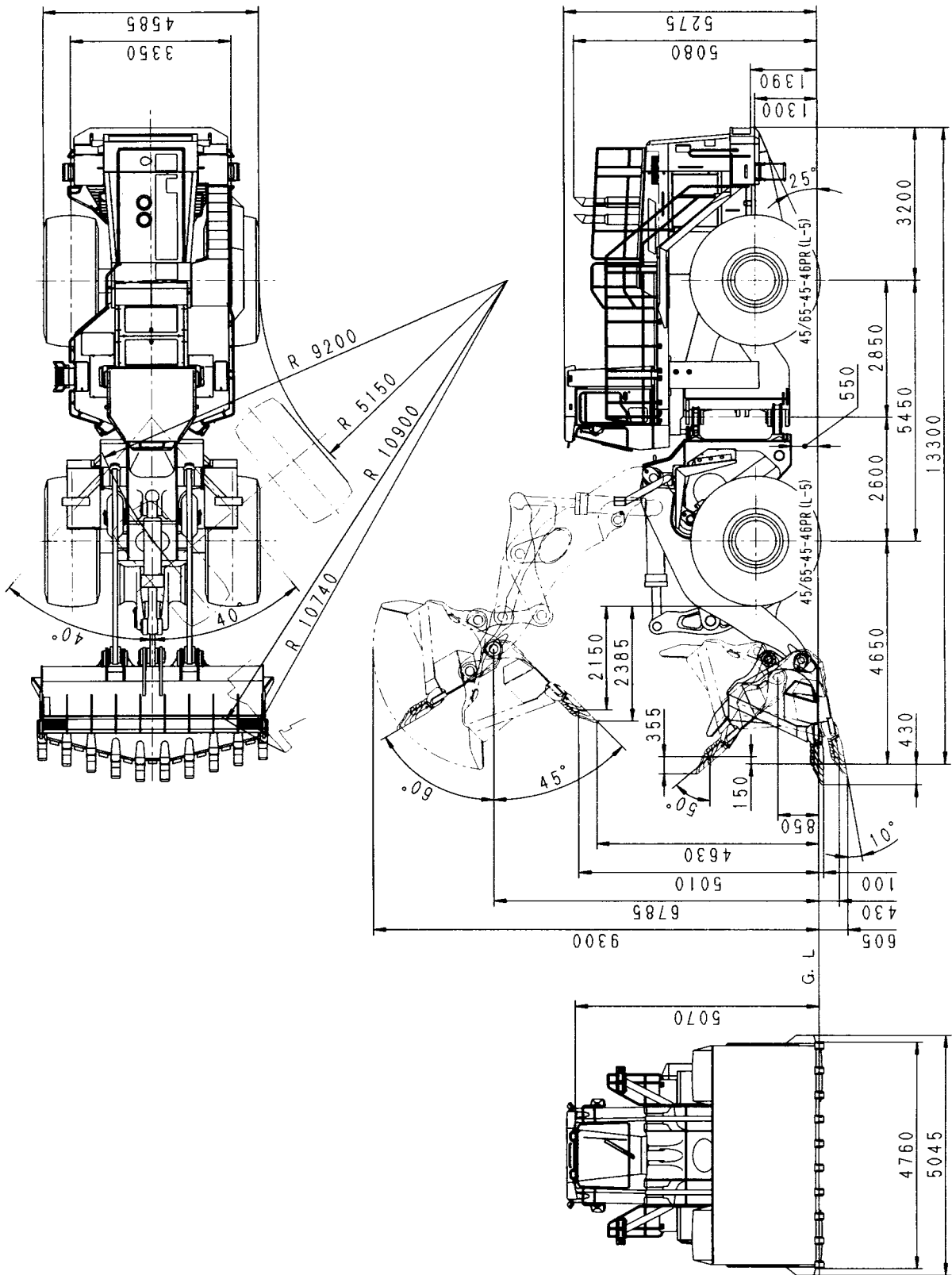

SWW03817

## SPECIFICATIONS

Machine model			WA800-3		
Serial No.			50001 – 50025	50026 and up	
Weight	Operating weight		kg	98,300	
	Distribution (front)		kg	57,300	
	Distribution (rear)		kg	41,000	
Performance	Bucket capacity (piled)		m <sup>3</sup>	11.0	
	Rated load		kg	19,800	
	Travel speed	FORWARD 1st		km/h	7.0
		FORWARD 2nd		km/h	12.3
		FORWARD 3rd		km/h	28.0
		REVERSE 1st		km/h	7.1
		REVERSE 2nd		km/h	12.4
		REVERSE 3rd		km/h	28.3
	Max. rimpull		kN {kg}	588.4 {60,000}	
	Gradeability		deg	25	
Min. turning radius	Center of outside wheel		mm	9,200	
	Outside portion of chassis		mm	10,900	
Dimensions	Overall length		mm	13,730 (with tooth)	
	Overall width (chassis)		mm	4,585	
	Bucket width		mm	4,760 (Cutting edge) 5,045 (Tire guard)	
	Overall height	(top of ROPS cab)		mm	5,275
		(Bucket raised)		mm	9,300
	Wheelbase		mm	5,450	
	Tread		mm	3,350	
	Min. ground clearance		mm	550	
	Height of bucket hinge pin		mm	6,785	
	Dumping clearance (tip of edge)		mm	5,010	
	Dumping reach (tip of edge)		mm	2,150	
	Bucket dump angle		deg	50 (Max. height)	
Bucket tilt angle (SAE carrying position)		deg	50		
Digging depth (10° dump) (tip of edge)		mm	430		

Machine model		WA800-3		
Serial No.		50001 – 50025	50026 and up	
Engine	Model	SA12V140		
	Type	4-cycle, water-cooled, V type, 12-cylinder direct injection, with 2-turbocharger, after-cooler		
	No. of cylinders – bore × stroke	mm	12 – 140 × 165	
	Piston displacement	ℓ {cc}	30.48 {30,480}	
	Performance	Flywheel horsepower	kW/rpm {HP/rpm}	636/2,000 {853/2,000}
		Maximum torque	Nm/rpm {kgm/rpm}	3,727/1,400 {380/1,400}
		Fuel consumption ratio	g/kW-h {g/HP-h}	202.6 {151}
		High idling speed	rpm	2,220
		Low idling speed	rpm	650/850
	Starting motor		24 V 7.5 kW × 2	
Alternator		24 V 75 A		
Battery		12 V 200 Ah × 4		
Power train	Torque converter	3-element, 1-stage, single-phase (TCA51-1A)		
	Transmission	Planetary gear, multiple-disc, hydraulically actuated, modulation type		
	Reduction gear	Spiral bevel gear		
	Differential	Straight bevel gear		
	Final drive	Planetary gear, single reduction, oil bath		
Axle, wheel	Drive type	Front/rear-wheel drive		
	Front axle	Fixed-frame, full-floating		
	Rear axle	Center pin support type, full-floating		
	Tire	45/65-45-46PR(L-5)		
	Wheel rim	36.00 × 45WTB		
	Inflation pressure	kPa {kg/cm <sup>2</sup> }	515 {5.25}	
Brakes	Main brake	Front/rear wheel braking, separate front/rear wheel, wet disc, hydraulically actuated		
	Parking brake	Mounted on front axle input shaft, dry disc, hydraulically release spring apply		

Machine model				WA800-3	
Serial No.				50001 – 50025	50026 and up
Steering system	Type			Articulated type	
	Structure			Fully hydraulically power steering	
Hydraulic system	Hydraulic pump Delivery	Torque converter, transmission pump	ℓ/min	421 (Gear type: SAR(4)112+SAR(3)100)	421 (Gear type: SAR(4)112+SAR(3)100)
		Steering pump	ℓ/min	307 (Fixed capacity piston pump: HPF76+71)	307 (Fixed capacity piston pump: HPF76+71)
		Switch pump	ℓ/min	405 (Fixed capacity piston pump: HPF90+90)	405 (Fixed capacity piston pump: HPF95+95)
		PPC pump	ℓ/min	68 (Gear type: SAR(1)032)	68 (Gear type: SAR(1)032)
		Brake pump	ℓ/min	29 (Gear type: SAR(1)014)	29 (Gear type: SAR(1)014)
		Work equipment pump	ℓ/min	405 (Variable capacity piston pump: HPV90+90)	405 (Variable capacity piston pump: HPV95+95)
	Control valve Set pressure	Transmission valve	MPa {kg/cm <sup>2</sup> }	2.5 {25} (Spool type, electric control)	
		Steering demand valve	MPa {kg/cm <sup>2</sup> }	31.4 {320} (Fully hydraulic type)	
		PPC valve	MPa {kg/cm <sup>2</sup> }	3.7 {38} (2-lever type)	
		Main control valve	MPa {kg/cm <sup>2</sup> }	31.4 {320} (2-spool type)	
Cylinder	Steering cylinder No. – bore × stroke	mm	Reciprocating piston 2 – 160 × 503		
	Boom cylinder No. – bore × stroke	mm	Reciprocating piston 2 – 260 × 1,368		
	Bucket cylinder No. – bore × stroke	mm	Reciprocating piston 1 – 300 × 906		
Work equipment	Link type		Single Z bar link		
	Bucket edge type		Spade nose bucket with teeth		

## WEIGHT TABLE

⚠ This weight table is a guide for use when transporting or handling components.

Unit: kg

Machine model Serial No.	WA800-3	
	50001 – 50025	50026 and up
Engine	3,200	3,200
Radiator	1,200	1,200
Torque converter	590	590
Transmission	2,300	2,300
Damper	178	178
Upper drive shaft	58	58
Center drive shaft	184	184
Front drive shaft	171	171
Rear drive shaft	184	184
Center support	165	165
Front axle	8,190	8,190
Rear axle	7,700	7,700
Front differential assembly	1,226	1,226
Rear differential assembly	1,256	1,256
Planetary carrier assembly (each)	238	238
Planetary hub assembly (each)	600	600
Axle pivot (Rear axle)	286	286
Wheel (each)	874	874
Tire (each)	2,630	2,630
Steering demand valve	66	66
Steering cylinder (each)	206	206
Hydraulic tank	824	824
Work equipment pump	150	150
Parking brake assembly	185	185
Torque converter charging + PPC + brake pump	49	49
Switch pump	145	157
Steering pump	145	145
Fender and guard assembly	1,393	1,393
PPC valve	4	4

Unit: kg

Machine model	WA800-3	
	50001 – 50025	50026 and up
Serial No.		
Main control valve (each)	95	95
Boom cylinder (each)	998	998
Bucket cylinder	1,210	1,210
Engine hood	88 (Top) 28 (Side)	88 (Top) 28 (Side)
Front frame	7,319	7,319
Rear frame	8,800	8,800
Bucket link (including bushing)	593	593
Bellcrank (including bushing)	1,850	1,850
Boom (including bushing)	8,495	8,495
Bucket (with teeth)	11,430	11,430
Counterweight	2,900	2,900
Fuel tank	780	780
Battery (each)	59	59
Cab	430	430
Air conditioner unit	55	55
Operator's seat	48	48
Floor plate	348	348
ROPS support assembly	1,387	1,387



**Download the full PDF manual instantly.**

**Our customer service e-mail:**

**[aservicemanualpdf@yahoo.com](mailto:aservicemanualpdf@yahoo.com)**