

SHOP MANUAL

KOMATSU

ADVANCE

WA30-5

MACHINE MODEL

WA30-5

SERIAL NUMBER

22005 and up

- This shop manual may contain attachments and optional equipment that are not available in your area. Please consult your local Komatsu distributor for those items you may require. Materials and specifications are subject to change without notice.
- WA30-5 mount the 3D84E-3D and 3D84E-5X engine.
For details of the engine, see the 68E-88E Series Engine Shop Manual.

CONTENTS

	No. of page
01 GENERAL	01-1
10 STRUCTURE AND FUNCTION	10-1
20 TESTING AND ADJUSTING	20-1
30 DISASSEMBLY AND ASSEMBLY	30-1
40 MAINTENANCE STANDARD	40-1
90 OTHERS	90-1

SAFETY

SAFETY NOTICE

IMPORTANT SAFETY NOTICE

Proper service and repair is extremely important for safe machine operation. The service and repair techniques recommended by Komatsu and described in this manual are both effective and safe. Some of these techniques require the use of tools specially designed by Komatsu for the specific purpose.

To prevent injury to workers, the symbol  is used to mark safety precautions in this manual. The cautions accompanying these symbols should always be followed carefully. If any dangerous situation arises or may possibly arise, first consider safety, and take the necessary actions to deal with the situation.

GENERAL PRECAUTIONS

Mistakes in operation are extremely dangerous. Read the Operation and Maintenance Manual carefully BEFORE operating the machine.

1. Before carrying out any greasing or repairs, read all the precautions given on the decals which are fixed to the machine.
2. When carrying out any operation, always wear safety shoes and helmet. Do not wear loose work clothes, or clothes with buttons missing.
 - Always wear safety glasses when hitting parts with a hammer.
 - Always wear safety glasses when grinding parts with a grinder, etc.
3. If welding repairs are needed, always have a trained, experienced welder carry out the work. When carrying out welding work, always wear welding gloves, apron, hand shield, cap and other clothes suited for welding work.
4. When carrying out any operation with two or more workers, always agree on the operating procedure before starting. Always inform your fellow workers before starting any step of the operation. Before starting work, hang UNDER REPAIR signs on the controls in the operator's compartment.
5. Keep all tools in good condition and learn the correct way to use them.

6. Decide a place in the repair workshop to keep tools and removed parts. Always keep the tools and parts in their correct places. Always keep the work area clean and make sure that there is no dirt or oil on the floor. Smoke only in the areas provided for smoking. Never smoke while working.

PREPARATIONS FOR WORK

7. Before adding oil or making any repairs, park the machine on hard, level ground, and block the wheels or tracks to prevent the machine from moving.
8. Before starting work, lower blade, ripper, bucket or any other work equipment to the ground. If this is not possible, insert the safety pin or use blocks to prevent the work equipment from falling. In addition, be sure to lock all the control levers and hang warning signs on them.
9. When disassembling or assembling, support the machine with blocks, jacks or stands before starting work.
10. Remove all mud and oil from the steps or other places used to get on and off the machine. Always use the handrails, ladders or steps when getting on or off the machine. Never jump on or off the machine. If it is impossible to use the handrails, ladders or steps, use a stand to provide safe footing.

PRECAUTIONS DURING WORK

11. When removing the oil filler cap, drain plug or hydraulic pressure measuring plugs, loosen them slowly to prevent the oil from spurting out. Before disconnecting or removing components of the oil, water or air circuits, first remove the pressure completely from the circuit.
12. The water and oil in the circuits are hot when the engine is stopped, so be careful not to get burned.
Wait for the oil and water to cool before carrying out any work on the oil or water circuits.
13. Before starting work, remove the leads from the battery. Always remove the lead from the negative (-) terminal first.
14. When raising heavy components, use a hoist or crane.
Check that the wire rope, chains and hooks are free from damage.
Always use lifting equipment which has ample capacity.
Install the lifting equipment at the correct places.
Use a hoist or crane and operate slowly to prevent the component from hitting any other part.
Do not work with any part still raised by the hoist or crane.
15. When removing covers which are under internal pressure or under pressure from a spring, always leave two bolts in position on opposite sides. Slowly release the pressure, then slowly loosen the bolts to remove.
16. When removing components, be careful not to break or damage the wiring. Damaged wiring may cause electrical fires.
17. When removing piping, stop the fuel or oil from spilling out. If any fuel or oil drips onto the floor, wipe it up immediately. Fuel or oil on the floor can cause you to slip, or can even start fires.
18. As a general rule, do not use gasoline to wash parts. In particular, use only the minimum of gasoline when washing electrical parts.
19. Be sure to assemble all parts again in their original places.
Replace any damaged parts with new parts.
 - When installing hoses and wires, be sure that they will not be damaged by contact with other parts when the machine is being operated.
20. When installing high pressure hoses, make sure that they are not twisted. Damaged tubes are dangerous, so be extremely careful when installing tubes for high pressure circuits. Also, check that connecting parts are correctly installed.
21. When assembling or installing parts, always use the specified tightening torques. When installing protective parts such as guards, or parts which vibrate violently or rotate at high speed, be particularly careful to check that they are installed correctly.
22. When aligning two holes, never insert your fingers or hand. Be careful not to get your fingers caught in a hole.
23. When measuring hydraulic pressure, check that the measuring tool is correctly assembled before taking any measurements.
24. Take care when removing or installing the tracks of track-type machines.
When removing the track, the track separates suddenly, so never let anyone stand at either end of the track.

FOREWORD

GENERAL

This shop manual has been prepared as an aid to improve the quality of repairs by giving the serviceman an accurate understanding of the product and by showing him the correct way to perform repairs and make judgments. Make sure you understand the contents of this manual and use it to full effect at every opportunity.

This shop manual mainly contains the necessary technical information for operations performed in a service workshop. For ease of understanding, the manual is divided into the following chapters; these chapters are further divided into the each main group of components.

STRUCTURE AND FUNCTION

This section explains the structure and function of each component. It serves not only to give an understanding of the structure, but also serves as reference material for troubleshooting.

In addition, this section may contain hydraulic circuit diagrams, electric circuit diagrams, and maintenance standards.

TESTING AND ADJUSTING

This section explains checks to be made before and after performing repairs, as well as adjustments to be made at completion of the checks and repairs.

Troubleshooting charts correlating "Problems" with "Causes" are also included in this section.

DISASSEMBLY AND ASSEMBLY

This section explains the procedures for removing, installing, disassembling and assembling each component, as well as precautions for them.

MAINTENANCE STANDARD

This section gives the judgment standards for inspection of disassembled parts.

The contents of this section may be described in STRUCTURE AND FUNCTION.

OTHERS

This section mainly gives hydraulic circuit diagrams and electric circuit diagrams.

In addition, this section may give the specifications of attachments and options together.

NOTICE

The specifications contained in this shop manual are subject to change at any time and without any advance notice. Use the specifications given in the book with the latest date.

HOW TO READ THE SHOP MANUAL

VOLUMES

Shop manuals are issued as a guide to carrying out repairs. They are divided as follows:

- Chassis volume:** Issued for every machine model
- Engine volume:** Issued for each engine series
- Electrical volume:** } Each issued as one
- Attachments volume:** } volume to cover all models

These various volumes are designed to avoid duplicating the same information. Therefore, to deal with all repairs for any model, it is necessary that chassis, engine, electrical and attachment volumes be available.

DISTRIBUTION AND UPDATING

Any additions, amendments or other changes will be sent to KOMATSU distributors. Get the most up-to-date information before you start any work.

FILING METHOD

1. See the page number on the bottom of the page. File the pages in correct order.
2. Following examples show how to read the page number.
Example 1 (Chassis volume):

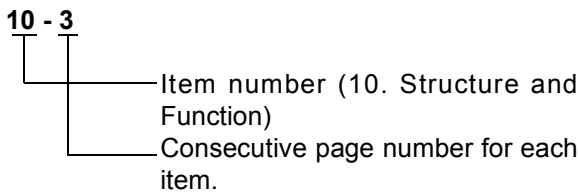

Example 2 (Engine volume):

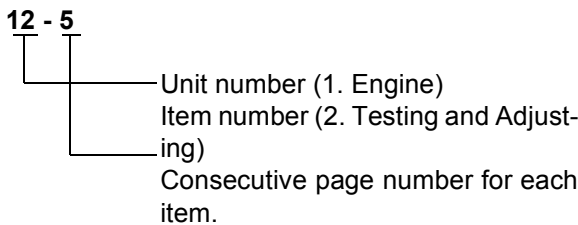

3. Additional pages: Additional pages are indicated by a hyphen (-) and number after the page number. File as in the example.

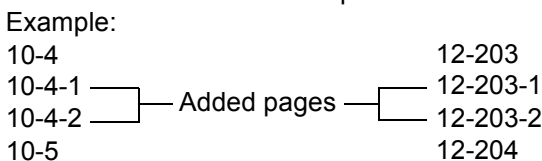

REVISED EDITION MARK

When a manual is revised, an edition mark ((1)(2)(3)....) is recorded on the bottom of the pages.

REVISIONS

Revised pages are shown in the LIST OF REVISED PAGES next to the CONTENTS page.

SYMBOLS

So that the shop manual can be of ample practical use, important safety and quality portions are marked with the following symbols.

Symbol	Item	Remarks
	Safety	Special safety precautions are necessary when performing the work.
	Caution	Special technical precautions or other precautions for preserving standards are necessary when performing the work.
	Weight	Weight of parts of systems. Caution necessary when selecting hoisting wire, or when working posture is important, etc.
	Tightening torque	Places that require special attention for the tightening torque during assembly.
	Coat	Places to be coated with adhesives and lubricants, etc.
	Oil, water	Places where oil, water or fuel must be added, and the capacity.
	Drain	Places where oil or water must be drained, and quantity to be drained.

HOISTING INSTRUCTIONS

HOISTING

⚠ Heavy parts (25 kg or more) must be lifted with a hoist, etc. In the **DISASSEMBLY AND ASSEMBLY** section, every part weighing 25 kg or more is indicated clearly with the symbol 

- If a part cannot be smoothly removed from the machine by hoisting, the following checks should be made:
 - 1) Check for removal of all bolts fastening the part to the relative parts.
 - 2) Check for existence of another part causing interference with the part to be removed.

WIRE ROPES

- 1) Use adequate ropes depending on the weight of parts to be hoisted, referring to the table below:

Wire ropes
(Standard "Z" or "S" twist ropes
without galvanizing)

Rope diameter	Allowable load	
	kN	tons
mm		
10	9.8	1.0
11.5	13.7	1.4
12.5	15.7	1.6
14	21.6	2.2
16	27.5	2.8
18	35.3	3.6
20	43.1	4.4
22.4	54.9	5.6
30	98.1	10.0
40	176.5	18.0
50	274.6	28.0
60	392.2	40.0

- ★ The allowable load value is estimated to be one-sixth or one-seventh of the breaking strength of the rope used.
- 2) Sling wire ropes from the middle portion of the hook.

Slinging near the edge of the hook may cause the rope to slip off the hook during hoisting, and a serious accident can result. Hooks have maximum strength at the middle portion.

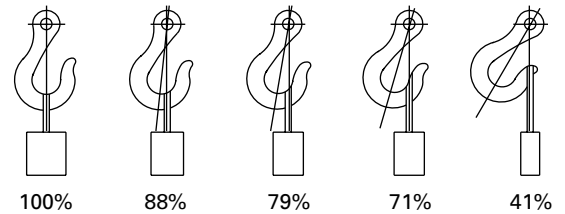

SAD00479

- 3) Do not sling a heavy load with one rope alone, but sling with two or more ropes symmetrically wound onto the load.

⚠ Slinging with one rope may cause turning of the load during hoisting, untwisting of the rope, or slipping of the rope from its original winding position on the load, which can result in a dangerous accident.

- 4) Do not sling a heavy load with ropes forming a wide hanging angle from the hook.

When hoisting a load with two or more ropes, the force subjected to each rope will increase with the hanging angles. The table below shows the variation of allowable load kN {kg} when hoisting is made with two ropes, each of which is allowed to sling up to 9.8 kN {1000 kg} vertically, at various hanging angles.

When two ropes sling a load vertically, up to 19.6 kN {2000 kg} of total weight can be suspended. This weight becomes 9.8 kN {1000 kg} when two ropes make a 120° hanging angle. On the other hand, two ropes are subjected to an excessive force as large as 39.2 kN {4000 kg} if they sling a 19.6 kN {2000 kg} load at a lifting angle of 150°.

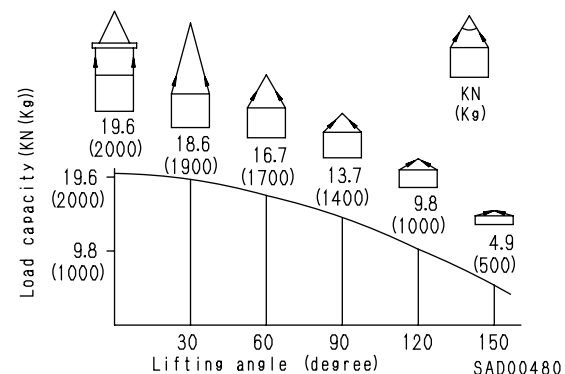

SAD00480

METHOD OF DISASSEMBLING, CONNECTING PUSH-PULL TYPE COUPLER

⚠ Before carrying out the following work, release the residual pressure from the hydraulic tank. For details, see TESTING AND ADJUSTING, Releasing residual pressure from hydraulic tank.

⚠ Even if the residual pressure is released from the hydraulic tank, some hydraulic oil flows out when the hose is disconnected. Accordingly, prepare an oil receiving container.

Disconnection

- 1) Release the residual pressure from the hydraulic tank. For details, see TESTING AND ADJUSTING, Releasing residual pressure from hydraulic tank.
- 2) Hold adapter (1) and push hose joint (2) into mating adapter (3). (See Fig. 1)
 - ★ The adapter can be pushed in about 3.5 mm.
 - ★ Do not hold rubber cap portion (4).
- 3) After hose joint (2) is pushed into adapter (3), press rubber cap portion (4) against (3) until it clicks. (See Fig. 2)
- 4) Hold hose adapter (1) or hose (5) and pull it out. (See Fig. 3)
 - ★ Since some hydraulic oil flows out, prepare an oil receiving container.

Connection

- 1) Hold hose adapter (1) or hose (5) and insert it in mating adapter (3), aligning them with each other. (See Fig. 4)
 - ★ Do not hold rubber cap portion (4).
- 2) After inserting the hose in the mating adapter perfectly, pull it back to check its connecting condition. (See Fig. 5)
 - ★ When the hose is pulled back, the rubber cap portion moves toward the hose about 3.5 mm. This does not indicate abnormality, however.

Type 1

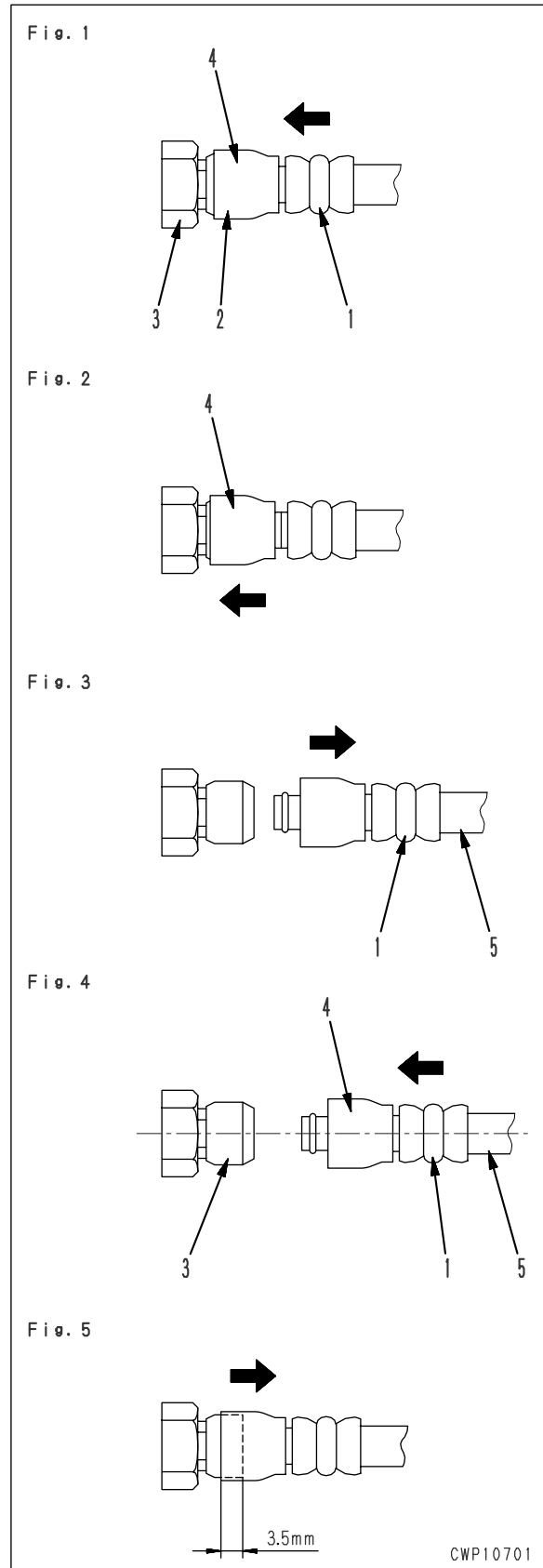

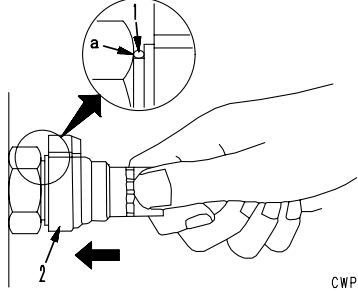
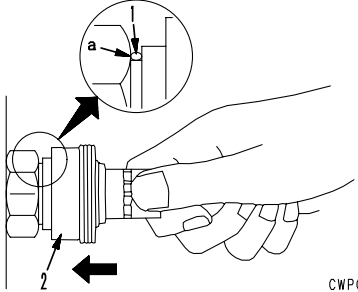
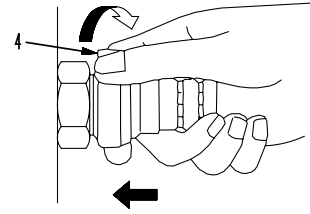
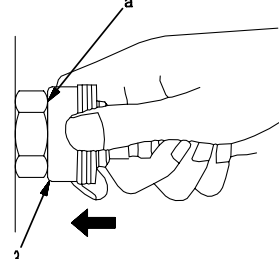
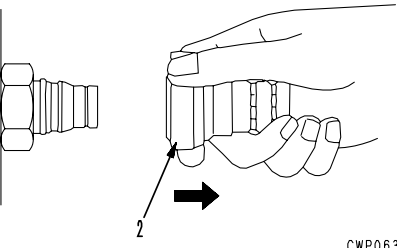
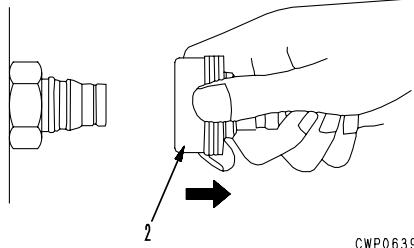
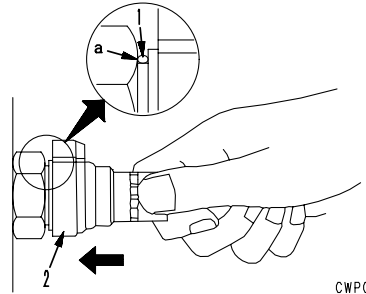
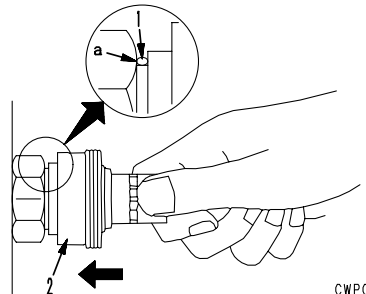
	Type 2	Type 3
Disassembly	<p>1) Hold the mouthpiece of the tightening portion and push body (2) in straight until sliding prevention ring (1) contacts contact surface a of the hexagonal portion at the male end.</p>  <p style="text-align: right;">CWP06392</p>	<p>1) Hold the mouthpiece of the tightening portion and push body (2) in straight until sliding prevention ring (1) contacts contact surface a of the hexagonal portion at the male end.</p>  <p style="text-align: right;">CWP06391</p>
	<p>2) Hold in the condition in Step 1), and turn lever (4) to the right (clockwise).</p>  <p style="text-align: right;">CWP06394</p>	<p>2) Hold in the condition in Step 1), and push until cover (3) contacts contact surface a of the hexagonal portion at the male end.</p>  <p style="text-align: right;">CWP06393</p>
	<p>3) Hold in the condition in Steps 1) and 2), and pull out whole body (2) to disconnect it.</p>  <p style="text-align: right;">CWP06396</p>	<p>3) Hold in the condition in Steps 1) and 2), and pull out whole body (2) to disconnect it.</p>  <p style="text-align: right;">CWP06395</p>
Connection	<ul style="list-style-type: none"> Hold the mouthpiece of the tightening portion and push body (2) in straight until sliding prevention ring (1) contacts contact surface a of the hexagonal portion at the male end to connect it.  <p style="text-align: right;">CWP06392</p>	<ul style="list-style-type: none"> Hold the mouthpiece of the tightening portion and push body (2) in straight until sliding prevention ring (1) contacts contact surface a of the hexagonal portion at the male end to connect it.  <p style="text-align: right;">CWP06391</p>

COATING MATERIALS

★ The recommended coating materials such as adhesives, gasket sealants and greases used for disassembly and assembly are listed below.

★ For coating materials not listed below, use the equivalent of products shown in this list.

Category	Komatsu code	Part No.	Q'ty	Container	Main applications, features
Adhesives	LT-1A	790-129-9030	150 g	Tube	<ul style="list-style-type: none"> Used to prevent rubber gaskets, rubber cushions, and cock plug from coming out.
	LT-1B	790-129-9050	20 g (2 pcs.)	Polyethylene container	<ul style="list-style-type: none"> Used in places requiring an immediately effective, strong adhesive. Used for plastics (except polyethylene, polypropylene, tetrafluoroethylene and vinyl chloride), rubber, metal and non-metal.
	LT-2	09940-00030	50 g	Polyethylene container	<ul style="list-style-type: none"> Features: Resistance to heat and chemicals Used for anti-loosening and sealant purpose for bolts and plugs.
	LT-3	790-129-9060 (Set of adhesive and hardening agent)	Adhesive: 1 kg Hardening agent: 500 g	Can	<ul style="list-style-type: none"> Used as adhesive or sealant for metal, glass and plastic.
	LT-4	790-129-9040	250 g	Polyethylene container	<ul style="list-style-type: none"> Used as sealant for machined holes.
	Holtz MH 705	790-126-9120	75 g	Tube	<ul style="list-style-type: none"> Used as heat-resisting sealant for repairing engine.
	Three bond 1735	790-129-9140	50 g	Polyethylene container	<ul style="list-style-type: none"> Quick hardening type adhesive Cure time: within 5 sec. to 3 min. Used mainly for adhesion of metals, rubbers, plastics and woods.
	Aron-alpha 201	790-129-9130	2 g	Polyethylene container	<ul style="list-style-type: none"> Quick hardening type adhesive Quick cure type (max. strength after 30 minutes) Used mainly for adhesion of rubbers, plastics and metals.
	Loctite 648-50	79A-129-9110	50 cc	Polyethylene container	<ul style="list-style-type: none"> Resistance to heat, chemicals Used at joint portions subject to high temperatures.
Gasket sealant	LG-1	790-129-9010	200 g	Tube	<ul style="list-style-type: none"> Used as adhesive or sealant for gaskets and packing of power train case, etc.
	LG-5	790-129-9080	1 kg	Can	<ul style="list-style-type: none"> Used as sealant for various threads, pipe joints, flanges. Used as sealant for tapered plugs, elbows, nipples of hydraulic piping.
	LG-6	790-129-9020	200 g	Tube	<ul style="list-style-type: none"> Features: Silicon based, resistance to heat, cold Used as sealant for flange surface, tread. Used as sealant for oil pan, final drive case, etc.
	LG-7	790-129-9070	1 g	Tube	<ul style="list-style-type: none"> Features: Silicon based, quick hardening type Used as sealant for flywheel housing, intake manifold, oil an, thermostat housing, etc.
	Three bond 1211	790-129-9090	100 g	Tube	<ul style="list-style-type: none"> Used as heat-resisting sealant for repairing engine.
	Three bond 1207B	419-15-18131	100 g	Tube	<ul style="list-style-type: none"> Features: Silicone type, heat resistant, vibration resistant, and impact resistant sealing material Used as sealing material for transfer case

Category	Komatsu code	Part No.	Q'ty	Container	Main applications, featuresr	
Molybdenum disulphide lubricant	LM-G	09940-00051	60 g	Can	<ul style="list-style-type: none"> Used as lubricant for sliding portion (to prevent from squeaking). 	
	LM-P	09940-00040	200 g	Tube	<ul style="list-style-type: none"> Used to prevent seizure or scuffing of the thread when press fitting or shrink fitting. Used as lubricant for linkage, bearings, etc. 	
Grease	G2-LI	SYG2-400LI SYG2-350LI SYG2-400LI-A SYG2-160LI SYGA-160CNLI	Various	Various	<ul style="list-style-type: none"> General purpose type 	
	G2-CA	SYG2-400CA SYG2-350CA SYG2-400CA-A SYG2-160CA SYGA-160CNCA	Various	Various	<ul style="list-style-type: none"> Used for normal temperature, light load bearing at places in contact with water or steam. 	
	Molybdenum disulphide grease LM-G (G2-M)	SYG2-400M SYG2-400M-A SYGA-16CNM	400 g × 10 400 g × 20 16 kg	Bellows type Bellows type Can	<ul style="list-style-type: none"> Used for heavy load portion 	
	Hyper White Grease G2-T G0-T (*) *: For use in cold district	SYG2-400T-A SYG2-16CNT SYG0-400T-A (*) SYG0-16CNT (*)	400 g 16 kg	Bellows type Can	<ul style="list-style-type: none"> Seizure resistance and heat resistance higher than molybdenum disulfide grease Since this grease is white, it does not stand out against machine body. 	
	Biogrease G2B G2-BT (*) *: For high temperature and large load	SYG2-400B SYGA-16CNCB SYG2-400BT (*) SYGA-16CNBT (*)	400 g 16 kg	Bellows type Can	<ul style="list-style-type: none"> Since this grease is decomposed by bacteria in short period, it has less effects on microorganisms, animals, and plants. 	
Primer	SUNSTAR PAINT PRIMER 580 SUPER	417-926-3910	20 ml	Glass container	Adhesive for cab glass	<ul style="list-style-type: none"> Used as primer for cab side (Using limit: 4 months)
	SUNSTAR GLASS PRIMER 580 SUPER		20 ml	Glass container		<ul style="list-style-type: none"> Used as primer for glass side (Using limit: 4 months)
Adhesive	SUNSTAR PENGUINE SEAL 580 SUPER "S" or "W"		320 ml	Polyethylene container		<ul style="list-style-type: none"> "S" is used for high-temperature season (April - October) and "W" for low-temperature season (November - April) as adhesive for glass. (Using limit: 4 months)
	Sika Japan, Sikaflex 256HV	20Y-54-39850	310 ml	Polyethylene container		<ul style="list-style-type: none"> Used as adhesive for glass. (Using limit: 6 months)
Caulking material	SUNSTAR PENGUINE SEAL No. 2505	417-926-3920	320 ml	Polyethylene container		<ul style="list-style-type: none"> Used to seal joints of glass parts. (Using limit: 4 months)
	SEKISUI SILICONE SEALANT	20Y-54-55130	333 ml	Polyethylene container	<ul style="list-style-type: none"> Used to seal front window. (Using limit: 6 months) 	

STANDARD TIGHTENING TORQUE

STANDARD TIGHTENING TORQUE TABLE (WHEN USING TORQUE WRENCH)

★ In the case of metric nuts and bolts for which there is no special instruction, tighten to the torque given in the table below.

Thread diameter of bolt	Width across flats	Tightening torque	
		Nm	kgm
mm	mm		
6	10	11.8 – 14.7	1.2 – 1.5
8	13	27 – 34	2.8 – 3.5
10	17	59 – 74	6 – 7.5
12	19	98 – 123	10 – 12.5
14	22	153 – 190	15.5 – 19.5
16	24	235 – 285	23.5 – 29.5
18	27	320 – 400	33 – 41
20	30	455 – 565	46.5 – 58
22	32	610 – 765	62.5 – 78
24	36	785 – 980	80 – 100
27	41	1150 – 1440	118 – 147
30	46	1520 – 1910	155 – 195
33	50	1960 – 2450	200 – 250
36	55	2450 – 3040	250 – 310
39	60	2890 – 3630	295 – 370



CDL00372

Thread diameter of bolt	Width across flats	Tightening torque	
		Nm	kgm
mm	mm		
6	10	5.9 – 9.8	0.6 – 1.0
8	13	13.7 – 23.5	1.4 – 2.4
10	14	34.3 – 46.1	3.5 – 4.7
12	27	74.5 – 90.2	7.6 – 9.2



CDL00373

TABLE OF TIGHTENING TORQUES FOR FLARED NUTS

★ In the case of flared nuts for which there is no special instruction, tighten to the torque given in the table below.

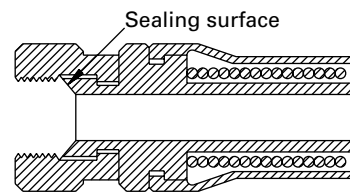

SAD00483

Thread diameter	Width across flat	Tightening torque	
		Nm	kgm
mm	mm		
14	19	24.5 ± 4.9	2.5 ± 0.5
18	24	49 ± 19.6	5 ± 2
22	27	78.5 ± 19.6	8 ± 2
24	32	137.3 ± 29.4	14 ± 3
30	36	176.5 ± 29.4	18 ± 3
33	41	196.1 ± 49	20 ± 5
36	46	245.2 ± 49	25 ± 5
42	55	294.2 ± 49	30 ± 5

TABLE OF TIGHTENING TORQUES FOR SPLIT FLANGE BOLTS

★ In the case of split flange bolts for which there is no special instruction, tighten to the torque given in the table below.

Thread diameter	Width across flat	Tightening torque	
		Nm	kgm
mm	mm		
10	14	59 – 74	6 – 7.5
12	17	98 – 123	10 – 12.5
16	22	235 – 285	23.5 – 29.5

TABLE OF TIGHTENING TORQUES FOR O-RING BOSS PIPING JOINTS

★ Unless there are special instructions, tighten the O-ring boss piping joints to the torque below.

Norminal No.	Thread diameter	Width across flat	Tightening torque (Nm {kgm})	
	mm	mm	Range	Target
02	14	Varies depending on type of connector.	35 – 63 {3.5 – 6.5}	44 {4.5}
03, 04	20		84 – 132 {8.5 – 13.5}	103 {10.5}
05, 06	24		128 – 186 {13.0 – 19.0}	157 {16.0}
10, 12	33		363 – 480 {37.0 – 49.0}	422 {43.0}
14	42		746 – 1010 {76.0 – 103}	883 {90.0}

TABLE OF TIGHTENING TORQUES FOR O-RING BOSS PLUGS

★ Unless there are special instructions, tighten the O-ring boss plugs to the torque below.

Norminal No.	Thread diameter	Width across flat	Tightening torque (Nm {kgm})	
	mm	mm	Range	Target
08	08	14	5.88 – 8.82 {0.6 – 0.9}	7.35 {0.75}
10	10	17	9.8 – 12.74 {1.0 – 1.3}	11.27 {1.15}
12	12	19	14.7 – 19.6 {1.5 – 2.0}	17.64 {1.8}
14	14	22	19.6 – 24.5 {2.0 – 2.5}	22.54 {2.3}
16	16	24	24.5 – 34.3 {2.5 – 3.5}	29.4 {3.0}
18	18	27	34.3 – 44.1 {3.5 – 4.5}	39.2 {4.0}
20	20	30	44.1 – 53.9 {4.5 – 5.5}	49.0 {5.0}
24	24	32	58.8 – 78.4 {6.0 – 8.0}	68.6 {7.0}
30	30	32	93.1 – 122.5 {9.5 – 12.5}	107.8 {11.0}
33	33	—	107.8 – 147.0 {11.0 – 15.0}	124.4 {13.0}
36	36	36	127.4 – 176.4 {13.0 – 18.0}	151.9 {15.5}
42	42	—	181.3 – 240.1 {18.5 – 24.5}	210.7 {21.5}
52	52	—	274.4 – 367.5 {28.0 – 37.5}	323.4 {33.0}

TIGHTENING TORQUE FOR 102 ENGINE SERIES

1) BOLT AND NUTS

Use these torques for bolts and nuts (unit: mm) of Cummins Engine.

Thread diameter	Tightening torque	
	mm	Nm
6	10 ± 2	1.02 ± 0.20
8	24 ± 4	2.45 ± 0.41
10	43 ± 6	4.38 ± 0.61
12	77 ± 12	7.85 ± 1.22

2) EYE JOINTS

Use these torques for eye joints (unit: mm) of Cummins Engine.

Thread diameter	Tightening torque	
	mm	Nm
6	8 ± 2	0.81 ± 0.20
8	10 ± 2	1.02 ± 0.20
10	12 ± 2	1.22 ± 0.20
12	24 ± 4	2.45 ± 0.41
14	36 ± 5	3.67 ± 0.51

3) TAPERED SCREWS

Use these torques for tapered screws (unit: inch) of Cummins Engine.

Thread diameter	Tightening torque	
	inch	Nm
1 / 16	3 ± 1	0.31 ± 0.10
1 / 8	8 ± 2	0.81 ± 0.20
1 / 4	12 ± 2	1.22 ± 0.20
3 / 8	15 ± 2	1.53 ± 0.41
1 / 2	24 ± 4	2.45 ± 0.41
3 / 4	36 ± 5	3.67 ± 0.51
1	60 ± 9	6.12 ± 0.92

TIGHTENING TORQUE TABLE FOR HOSES (TAPER SEAL TYPE AND FACE SEAL TYPE)

★ Tighten the hoses (taper seal type and face seal type) to the following torque, unless otherwise specified.

★ Apply the following torque when the threads are coated (wet) with engine oil.

Nominal size of hose	Width across flats	Tightening torque (Nm {kgm})		Taper seal type Thread size (mm)	Face seal type	
		Range	Target		Nominal thread size - Threads per inch, Thread series	Root diameter (mm) (Reference)
02	19	34 - 63 {3.5 - 6.5}	44 {4.5}	14	$\frac{9}{16}$ - 18UNF	14.3
03	22	54 - 93 {5.5 - 9.5}	74 {4.5}	-	$\frac{11}{16}$ - 16UN	17.5
	24	59 - 98 {6.0 - 10.0}	78 {8.0}	18	-	-
04	27	84 - 132 {8.5 - 13.5}	103 {10.5}	22	$\frac{13}{16}$ - 16UN	20.7
05	32	128 - 186 {13.0 - 19.0}	157 {16.0}	24	1 - 14UNS	25.4
06	36	177 - 245 {18.0 - 25.0}	216 {22.0}	30	$1\frac{3}{16}$ - 12UNF	30.3
(10)	41	177 - 245 {18.0 - 25.0}	216 {22.0}	33	-	-
(12)	46	197 - 294 {20.0 - 30.0}	245 {25.0}	36	-	-
(14)	55	246 - 343 {25.0 - 35.0}	294 {30.0}	42	-	-

ELECTRIC WIRE CODE

In the wiring diagrams, various colors and symbols are employed to indicate the thickness of wires. This wire code table will help you understand WIRING DIAGRAMS.
 Example: 5WB indicates a cable having a nominal number 5 and white coating with black stripe.

CLASSIFICATION BY THICKNESS

Nominal number	Copper wire			Cable O.D. (mm)	Current rating (A)	Applicable circuit
	Number of strands	Dia. of strands (mm ²)	Cross section (mm ²)			
0.85	11	0.32	0.88	2.4	12	Starting, lighting, signal etc.
2	26	0.32	2.09	3.1	20	Lighting, signal etc.
5	65	0.32	5.23	4.6	37	Charging and signal
15	84	0.45	13.36	7.0	59	Starting (Glow plug)
40	85	0.80	42.73	11.4	135	Starting
60	127	0.80	63.84	13.6	178	Starting
100	217	0.80	109.1	17.6	230	Starting

CLASSIFICATION BY COLOR AND CODE

Priority	Classification	Circuits	Charging	Ground	Starting	Lighting	Instrument	Signal	Other
			Code	Color	Code	Color	Code	Color	Code
1	Primary	Code	W	B	B	R	Y	G	L
		Color	White	Black	Black	Red	Yellow	Green	Blue
2	Auxiliary	Code	WR	—	BW	RW	YR	GW	LW
		Color	White & Red	—	White & Black	Red & White	Yellow & Red	Green & White	Blue & White
Code		WB	—	BY	RB	YB	GR	LR	
Color		White & Black	—	Black & Yellow	Red & Black	Yellow & Black	Green & Red	Blue & Yellow	
Code		WL	—	BR	RY	YG	GY	LY	
Color		White & Blue	—	Black & Red	Red & Yellow	Yellow & Green	Green & Yellow	Blue & Yellow	
Code		WG	—	—	RG	YL	GB	LB	
Color		White & Green	—	—	Red & Green	Yellow & Blue	Green & Black	Blue & Black	
6		Code	—	—	—	RL	YW	GL	—
		Color	—	—	—	Red & Blue	Yellow & White	Green & Blue	—

CONVERSION TABLE

METHOD OF USING THE CONVERSION TABLE

The Conversion Table in this section is provided to enable simple conversion of figures. For details of the method of using the Conversion Table, see the example given below.

EXAMPLE

- Method of using the Conversion Table to convert from millimeters to inches
1. Convert 55 mm into inches.
 - (1) Locate the number 50 in the vertical column at the left side, take this as (A), then draw a horizontal line from (A).
 - (2) Locate the number 5 in the row across the top, take this as (B), then draw a perpendicular line down from (B).
 - (3) Take the point where the two lines cross as (C). This point (C) gives the value when converting from millimeters to inches. Therefore, 55 mm = 2.165 inches.
 2. Convert 550 mm into inches.
 - (1) The number 550 does not appear in the table, so divide by 10 (move the decimal point one place to the left) to convert it to 55 mm.
 - (2) Carry out the same procedure as above to convert 55 mm to 2.165 inches.
 - (3) The original value (550 mm) was divided by 10, so multiply 2.165 inches by 10 (move the decimal point one place to the right) to return to the original value. This gives 550 mm = 21.65 inches.

1 mm = 0.03937 in

	0	1	2	3	4	5	6	7	8	9
0	0	0.039	0.079	0.118	0.157	0.197	0.236	0.276	0.315	0.354
10	0.394	0.433	0.472	0.512	0.551	0.591	0.630	0.669	0.709	0.748
20	0.787	0.827	0.866	0.906	0.945	0.984	1.024	1.063	1.102	1.142
30	1.181	1.220	1.260	1.299	1.339	1.378	1.417	1.457	1.496	1.536
40	1.575	1.614	1.654	1.693	1.732	1.772	1.811	1.850	1.890	1.929
(A) 50	1.969	2.008	2.047	2.087	2.126	2.165	2.205	2.244	2.283	2.323
60	2.362	2.402	2.441	2.480	2.520	2.559	2.598	2.638	2.677	2.717
70	2.756	2.795	2.835	2.874	2.913	2.953	2.992	3.032	3.071	3.110
80	3.150	3.189	3.228	3.268	3.307	3.346	3.386	3.425	3.465	3.504
90	3.543	3.583	3.622	3.661	3.701	3.740	3.780	3.819	3.858	3.898

Millimeters to Inches

1 mm = 0.03937 in

	0	1	2	3	4	5	6	7	8	9
0	0	0.039	0.079	0.118	0.157	0.197	0.236	0.276	0.315	0.354
10	0.394	0.433	0.472	0.512	0.551	0.591	0.630	0.669	0.709	0.748
20	0.787	0.827	0.866	0.906	0.945	0.984	1.024	1.063	1.102	1.142
30	1.181	1.220	1.260	1.299	1.339	1.378	1.417	1.457	1.496	1.536
40	1.575	1.614	1.654	1.693	1.732	1.772	1.811	1.850	1.890	1.929
50	1.969	2.008	2.047	2.087	2.126	2.165	2.205	2.244	2.283	2.323
60	2.362	2.402	2.441	2.480	2.520	2.559	2.598	2.638	2.677	2.717
70	2.756	2.795	2.835	2.874	2.913	2.953	2.992	3.032	3.071	3.110
80	3.150	3.189	3.228	3.268	3.307	3.346	3.386	3.425	3.465	3.504
90	3.543	3.583	3.622	3.661	3.701	3.740	3.780	3.819	3.858	3.898

Kilogram to Pound

1 kg = 2.2046 lb

	0	1	2	3	4	5	6	7	8	9
0	0	2.20	4.41	6.61	8.82	11.02	13.23	15.43	17.64	19.84
10	22.05	24.25	26.46	28.66	30.86	33.07	35.27	37.48	39.68	41.89
20	44.09	46.30	48.50	50.71	51.91	55.12	57.32	59.53	61.73	63.93
30	66.14	68.34	70.55	72.75	74.96	77.16	79.37	81.57	83.78	85.98
40	88.18	90.39	92.59	94.80	97.00	99.21	101.41	103.62	105.82	108.03
50	110.23	112.44	114.64	116.85	119.05	121.25	123.46	125.66	127.87	130.07
60	132.28	134.48	136.69	138.89	141.10	143.30	145.51	147.71	149.91	152.12
70	154.32	156.53	158.73	160.94	163.14	165.35	167.55	169.76	171.96	174.17
80	176.37	178.57	180.78	182.98	185.19	187.39	189.60	191.80	194.01	196.21
90	198.42	200.62	202.83	205.03	207.24	209.44	211.64	213.85	216.05	218.26

Liter to U.S. Gallon

1ℓ = 0.2642 U.S. Gal

	0	1	2	3	4	5	6	7	8	9
0	0	0.264	0.528	0.793	1.057	1.321	1.585	1.849	2.113	2.378
10	2.642	2.906	3.170	3.434	3.698	3.963	4.227	4.491	4.755	5.019
20	5.283	5.548	5.812	6.076	6.340	6.604	6.869	7.133	7.397	7.661
30	7.925	8.189	8.454	8.718	8.982	9.246	9.510	9.774	10.039	10.303
40	10.567	10.831	11.095	11.359	11.624	11.888	12.152	12.416	12.680	12.944
50	13.209	13.473	13.737	14.001	14.265	14.529	14.795	15.058	15.322	15.586
60	15.850	16.115	16.379	16.643	16.907	17.171	17.435	17.700	17.964	18.228
70	18.492	18.756	19.020	19.285	19.549	19.813	20.077	20.341	20.605	20.870
80	21.134	21.398	21.662	21.926	22.190	22.455	22.719	22.983	23.247	23.511
90	23.775	24.040	24.304	24.568	24.832	25.096	25.361	25.625	25.889	26.153

Liter to U.K. Gallon

1ℓ = 0.21997 U.K. Gal

	0	1	2	3	4	5	6	7	8	9
0	0	0.220	0.440	0.660	0.880	1.100	1.320	1.540	1.760	1.980
10	2.200	2.420	2.640	2.860	3.080	3.300	3.520	3.740	3.950	4.179
20	4.399	4.619	4.839	5.059	5.279	5.499	5.719	5.939	6.159	6.379
30	6.599	6.819	7.039	7.259	7.479	7.699	7.919	8.139	8.359	8.579
40	8.799	9.019	9.239	9.459	9.679	9.899	10.119	10.339	10.559	10.778
50	10.998	11.281	11.438	11.658	11.878	12.098	12.318	12.528	12.758	12.978
60	13.198	13.418	13.638	13.858	14.078	14.298	14.518	14.738	14.958	15.178
70	15.398	15.618	15.838	16.058	16.278	16.498	16.718	16.938	17.158	17.378
80	17.598	17.818	18.037	18.257	18.477	18.697	18.917	19.137	19.357	19.577
90	19.797	20.017	20.237	20.457	20.677	20.897	21.117	21.337	21.557	21.777

kgm to ft. lb

1 kgm = 7.233 ft. lb

	0	1	2	3	4	5	6	7	8	9
0	0	7.2	14.5	21.7	28.9	36.2	43.4	50.6	57.9	65.1
10	72.3	79.6	86.8	94.0	101.3	108.5	115.7	123.0	130.2	137.4
20	144.7	151.9	159.1	166.4	173.6	180.8	188.1	195.3	202.5	209.8
30	217.0	224.2	231.5	238.7	245.9	253.2	260.4	267.6	274.9	282.1
40	289.3	296.6	303.8	311.0	318.3	325.5	332.7	340.0	347.2	354.4
50	361.7	368.9	376.1	383.4	390.6	397.8	405.1	412.3	419.5	426.8
60	434.0	441.2	448.5	455.7	462.9	470.2	477.4	484.6	491.8	499.1
70	506.3	513.5	520.8	528.0	535.2	542.5	549.7	556.9	564.2	571.4
80	578.6	585.9	593.1	600.3	607.6	614.8	622.0	629.3	636.5	643.7
90	651.0	658.2	665.4	672.7	679.9	687.1	694.4	701.6	708.8	716.1
100	723.3	730.5	737.8	745.0	752.2	759.5	766.7	773.9	781.2	788.4
110	795.6	802.9	810.1	817.3	824.6	831.8	839.0	846.3	853.5	860.7
120	868.0	875.2	882.4	889.7	896.9	904.1	911.4	918.6	925.8	933.1
130	940.3	947.5	954.8	962.0	969.2	976.5	983.7	990.9	998.2	1005.4
140	1012.6	1019.9	1027.1	1034.3	1041.5	1048.8	1056.0	1063.2	1070.5	1077.7
150	1084.9	1092.2	1099.4	1106.6	1113.9	1121.1	1128.3	1135.6	1142.8	1150.0
160	1157.3	1164.5	1171.7	1179.0	1186.2	1193.4	1200.7	1207.9	1215.1	1222.4
170	1129.6	1236.8	1244.1	1251.3	1258.5	1265.8	1273.0	1280.1	1287.5	1294.7
180	1301.9	1309.2	1316.4	1323.6	1330.9	1338.1	1345.3	1352.6	1359.8	1367.0
190	1374.3	1381.5	1388.7	1396.0	1403.2	1410.4	1417.7	1424.9	1432.1	1439.4

kg/cm² to lb/in²

1kg/cm² = 14.2233 lb/in²

	0	1	2	3	4	5	6	7	8	9
0	0	14.2	28.4	42.7	56.9	71.1	85.3	99.6	113.8	128.0
10	142.2	156.5	170.7	184.9	199.1	213.4	227.6	241.8	256.0	270.2
20	284.5	298.7	312.9	327.1	341.4	355.6	369.8	384.0	398.3	412.5
30	426.7	440.9	455.1	469.4	483.6	497.8	512.0	526.3	540.5	554.7
40	568.9	583.2	597.4	611.6	625.8	640.1	654.3	668.5	682.7	696.9
50	711.2	725.4	739.6	753.8	768.1	782.3	796.5	810.7	825.0	839.2
60	853.4	867.6	881.8	896.1	910.3	924.5	938.7	953.0	967.2	981.4
70	995.6	1010	1024	1038	1053	1067	1081	1095	1109	1124
80	1138	1152	1166	1181	1195	1209	1223	1237	1252	1266
90	1280	1294	1309	1323	1337	1351	1365	1380	1394	1408
100	1422	1437	1451	1465	1479	1493	1508	1522	1536	1550
110	1565	1579	1593	1607	1621	1636	1650	1664	1678	1693
120	1707	1721	1735	1749	1764	1778	1792	1806	1821	1835
130	1849	1863	1877	1892	1906	1920	1934	1949	1963	1977
140	1991	2005	2020	2034	2048	2062	2077	2091	2105	2119
150	2134	2148	2162	2176	2190	2205	2219	2233	2247	2262
160	2276	2290	2304	2318	2333	2347	2361	2375	2389	2404
170	2418	2432	2446	2460	2475	2489	2503	2518	2532	2546
180	2560	2574	2589	2603	2617	2631	2646	2660	2674	2688
190	2702	2717	2731	2745	2759	2773	2788	2802	2816	2830
200	2845	2859	2873	2887	2901	2916	2930	2944	2958	2973
210	2987	3001	3015	3030	3044	3058	3072	3086	3101	3115
220	3129	3143	3158	3172	3186	3200	3214	3229	3243	3257
230	3271	3286	3300	3314	3328	3343	3357	3371	3385	3399
240	3414	3428	3442	3456	3470	3485	3499	3513	3527	3542

Temperature

Fahrenheit-Centigrade Conversion ; a simple way to convert a Fahrenheit temperature reading into a Centigrade temperature reading or vice versa is to enter the accompanying table in the center or boldface column of figures.

These figures refer to the temperature in either Fahrenheit or Centigrade degrees.

If it is desired to convert from Fahrenheit to Centigrade degrees, consider the center column as a table of Fahrenheit temperatures and read the corresponding Centigrade temperature in the column at the left.

If it is desired to convert from Centigrade to Fahrenheit degrees, consider the center column as a table of Centigrade values, and read the corresponding Fahrenheit temperature on the right.

$$1^{\circ}\text{C} = 33.8^{\circ}\text{F}$$

°C		°F	°C		°F	°C		°F	°C		°F
-40.4	-40	-40.0	-11.7	11	51.8	7.8	46	114.8	27.2	81	117.8
-37.2	-35	-31.0	-11.1	12	53.6	8.3	47	116.6	27.8	82	179.6
-34.4	-30	-22.0	-10.6	13	55.4	8.9	48	118.4	28.3	83	181.4
-31.7	-25	-13.0	-10.0	14	57.2	9.4	49	120.2	28.9	84	183.2
-28.9	-20	-4.0	-9.4	15	59.0	10.0	50	122.0	29.4	85	185.0
-28.3	-19	-2.2	-8.9	16	60.8	10.6	51	123.8	30.0	86	186.8
-27.8	-18	-0.4	-8.3	17	62.6	11.1	52	125.6	30.6	87	188.6
-27.2	-17	1.4	-7.8	18	64.4	11.7	53	127.4	31.1	88	190.4
-26.7	-16	3.2	-7.2	19	66.2	12.2	54	129.2	31.7	89	192.2
-26.1	-15	5.0	-6.7	20	68.0	12.8	55	131.0	32.2	90	194.0
-25.6	-14	6.8	-6.1	21	69.8	13.3	56	132.8	32.8	91	195.8
-25.0	-13	8.6	-5.6	22	71.6	13.9	57	134.6	33.3	92	197.6
-24.4	-12	10.4	-5.0	23	73.4	14.4	58	136.4	33.9	93	199.4
-23.9	-11	12.2	-4.4	24	75.2	15.0	59	138.2	34.4	94	201.2
-23.3	-10	14.0	-3.9	25	77.0	15.6	0	140.0	35.0	95	203.0
-22.8	-9	15.8	-3.3	26	78.8	16.1	61	141.8	35.6	96	204.8
-22.2	-8	17.6	-2.8	27	80.6	16.7	62	143.6	36.1	97	206.6
-21.7	-7	19.4	-2.2	28	82.4	17.2	63	145.4	36.7	98	208.4
-21.1	-6	21.2	-1.7	29	84.2	17.8	64	147.2	37.2	99	210.2
-20.6	-5	23.0	-1.1	30	86.0	18.3	65	149.0	37.8	100	212.0
-20.0	-4	24.8	-0.6	31	87.8	18.9	66	150.8	40.6	105	221.0
-19.4	-3	26.6	0	32	89.6	19.4	67	152.6	43.3	110	230.0
-18.9	-2	28.4	0.6	33	91.4	20.0	68	154.4	46.1	115	239.0
-18.3	-1	30.2	1.1	34	93.2	20.6	69	156.2	48.9	120	248.0
-17.8	0	32.0	1.7	35	95.0	21.1	70	158.0	51.7	125	257.0
-17.2	1	33.8	2.2	36	96.8	21.7	71	159.8	54.4	130	266.0
-16.7	2	35.6	2.8	37	98.6	22.2	72	161.6	57.2	135	275.0
-16.1	3	37.4	3.3	38	100.4	22.8	73	163.4	60.0	140	284.0
-15.6	4	39.2	3.9	39	102.2	23.3	74	165.2	62.7	145	293.0
-15.0	5	41.0	4.4	40	104.0	23.9	75	167.0	65.6	150	302.0
-14.4	6	42.8	5.0	41	105.8	24.4	76	168.8	68.3	155	311.0
-13.9	7	44.6	5.6	42	107.6	25.0	77	170.6	71.1	160	320.0
-13.3	8	46.4	6.1	43	109.4	25.6	78	172.4	73.9	165	329.0
-12.8	9	48.2	6.7	44	111.2	26.1	79	174.2	76.7	170	338.0
-12.2	10	50.0	7.2	45	113.0	26.7	80	176.0	79.4	175	347.0

UNITS

In this manual, the measuring units are indicated with International System of units (SI).
As for reference, conventionally used Gravitational System of units are indicated in parentheses { }.

Example:

N {kg}
Nm {kgm}
MPa {kg/cm²}
kPa {mmH₂O}
kPa {mmHg}
kW/rpm {HP/rpm}
g/kWh {g/HPh}

01 GENERAL

General assembly drawing	01- 2
Specifications	01- 4
Weight table	01- 7
List of lubricant and water	01- 8

GENERAL ASSEMBLY DRAWING

WA30-5

Unit: mm

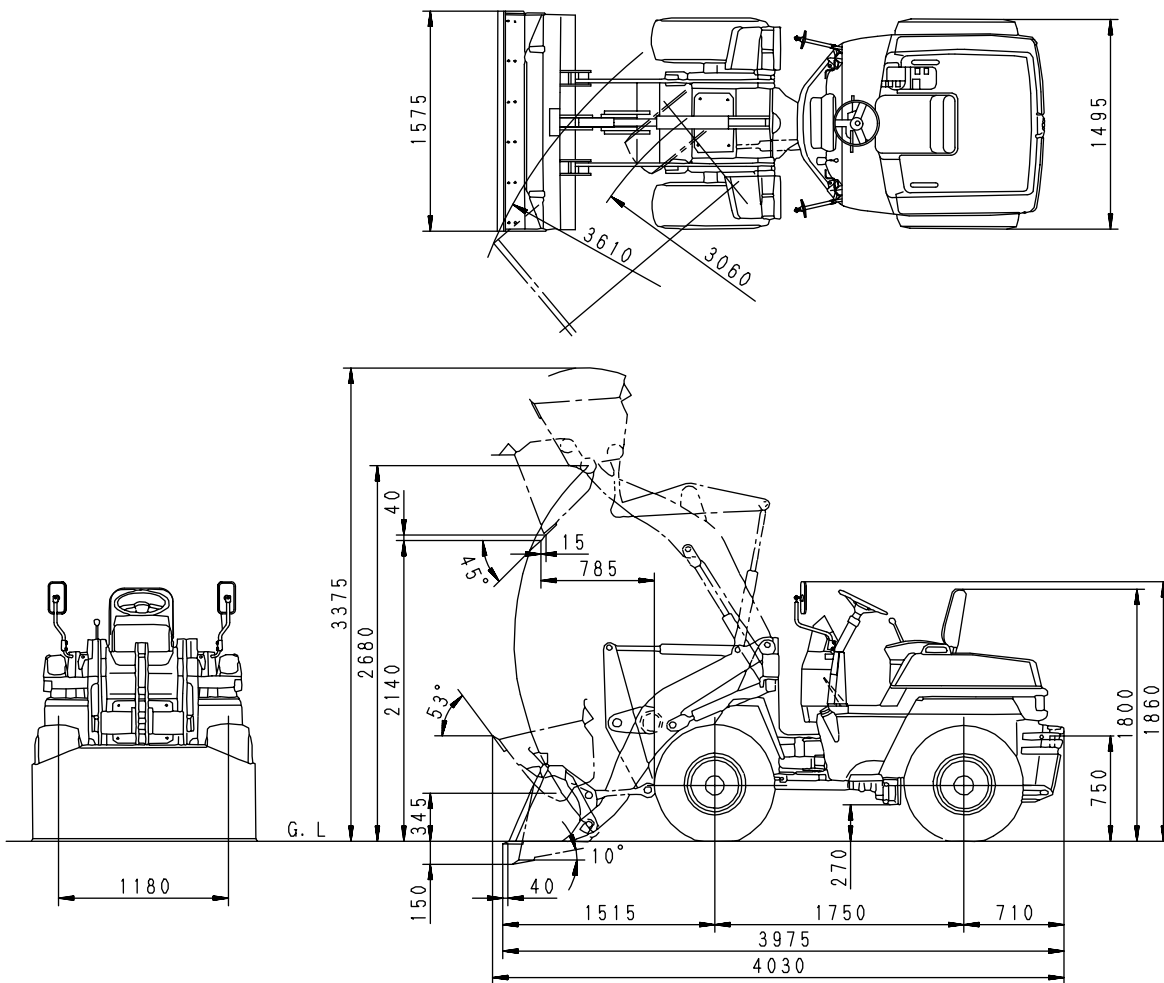

SJW06896

WA30-5 (with ROPS canopy)

Unit: mm

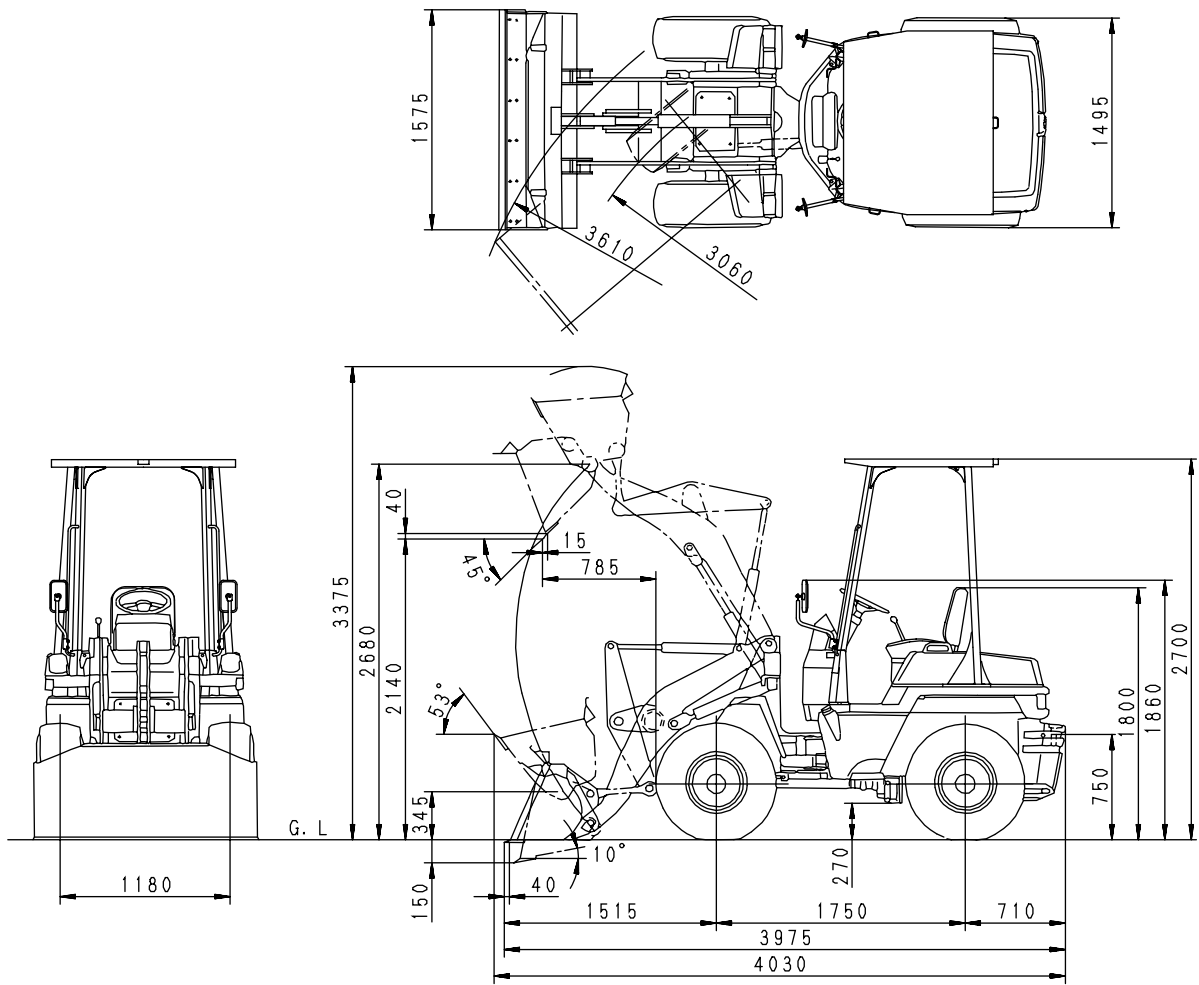

SWW04634

SPECIFICATIONS

Machine model			WA30-5		
Serial No.			22005 and up		
Weight			Without ROPS canopy	Without ROPS canopy	
	Operating weight	kg	2,555	2,740	
	Distribution (front)	kg	1,190	1,055	
	Distribution (rear)	kg	1,365	1,685	
Performance	Bucket capacity (heaped) (With tooth)		0.4		
	Rated load		640		
	Travel speed (Forward)		15		
	(Reverse)		15		
	Max. rimpull (Forward)		25.5 {2,600}		
	Gradeability		30		
	Min. turning radius	Center of outside wheel	mm	3,060	
		Outside portion of bucket	mm	3,610	
	Dimensions	Overall length (bucket on the ground)		3,975	
		Overall width		1,495	
Bucket width		1,575			
Overall height (Top of ROPS canopy)		2,455	2,700		
(Bucket raised)		3,375			
Wheelbase		1,750			
Tread		1,180			
Min. ground clearance		270			
Height of bucket hinge pin		2,680			
Dumping clearance (tip of BOC)		2,140			
Dumping reach (tip of BOC)		785			
Bucket dump angle (front)		45			
Bucket tilt angle (Rear, travelling posture)		53			
Digging depth (10° front and rear)		150			

BOC: Bolt-on cutting edge.



Download the full PDF manual instantly.

Our customer service e-mail:

aservicemanualpdf@yahoo.com