

Product: EXCAVATOR

Model: 336D2 L EXCAVATOR GJA

Configuration: 336D2 L Excavators GJA00001-UP (MACHINE) POWERED BY C9 Engine

Disassembly and Assembly 336D 2L and 340D 2L Excavators Machine Systems

Media Number -M0065626-02

Publication Date -01/09/2015

Date Updated -14/12/2017

i06605028

Travel Motor - Disassemble

SMCS - 4351-015

Disassembly Procedure

Table 1

Required Tools			
Tool	Part Number	Part Description	Qty
A	1U-7506	Adapter	1
	8T-4244	Nut	6
	8T-4223	Hard Washer	6
	-	M12 x 1.75 x 250 mm (10 inch) Threaded Rod	1
B	8T-0651	Bolt	1
	8T-4167	Hard Washer	1
C	3E-3882	Eyebolt	1
D	1P-1859	Retaining Ring Pliers	1
E	1P-0510	Driver Gp	1
	9S-9152	Bearing Puller Gp	1
F	1P-1861	Retaining Ring Pliers	1

Start By:

- a. Remove the travel motor.
 1. Fasten the travel motor in Tooling (A) in a vertical position. The weight of the travel motor is approximately 88 kg (195 lb).

- Put an alignment mark across the head and the body of the travel motor for assembly purposes. The head must be reinstalled in the head's original position on the body of the travel motor.



Illustration 1

g00887295

WARNING

Personal injury can result from being struck by parts propelled by a released spring force.

Make sure to wear all necessary protective equipment.

Follow the recommended procedure and use all recommended tooling to release the spring force.

Note: During the removal of head (2) from the travel motor, be careful not to damage the mating surfaces of the components.

- Remove bolts (1).
- Remove head (2) from the body of the travel motor.

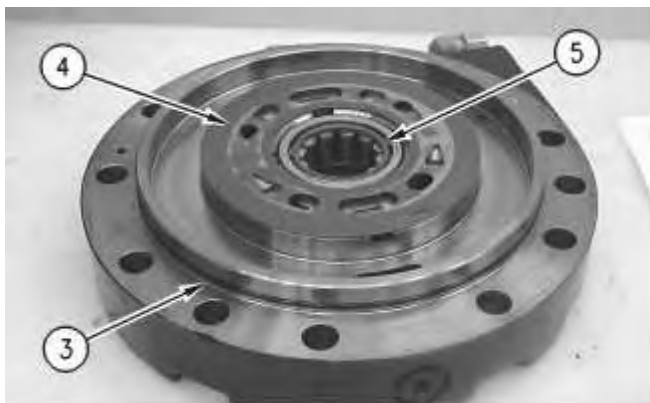

5. Remove O-ring seal (3), port plate (4), and bearing (5).

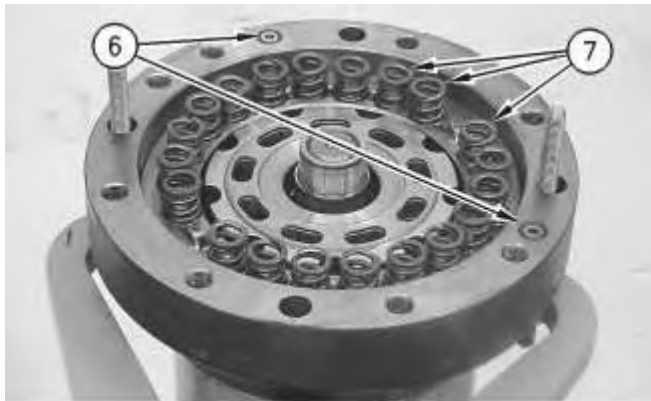

Illustration 3

6. Remove O-ring seals (6). Remove springs (7).

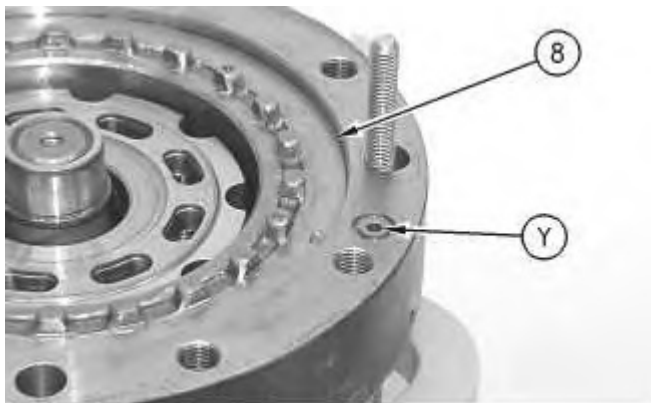

Illustration 4

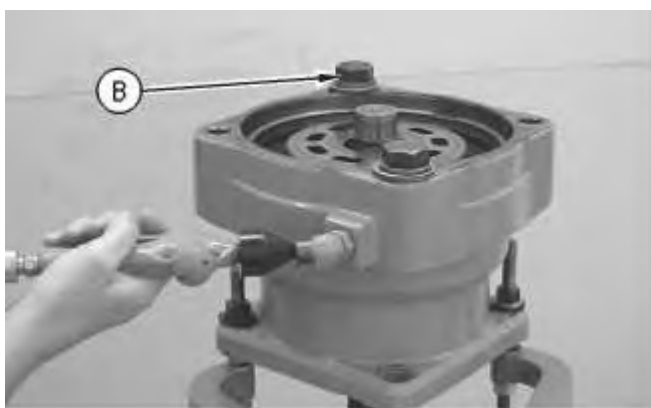

Illustration 5

Example of the use of Tooling (B).

7. Place a shop towel over brake piston (8). Retain brake piston (8) with Tooling (B). Apply approximately 525 kPa (75 psi) of shop air pressure to brake release Port (Y). Make sure that the shop air pressure is free of water. Brake piston (8) will move up the piston guide, and out of the piston guide. Remove brake piston (8) from the body of the travel motor.



Illustration 6

g00887336

8. Remove seal (9) and backup ring (10) from the brake piston.
9. Remove seal (11) and backup ring (12) from the brake piston.



Illustration 7

g00887355

10. Remove plates (13) and friction discs (14).

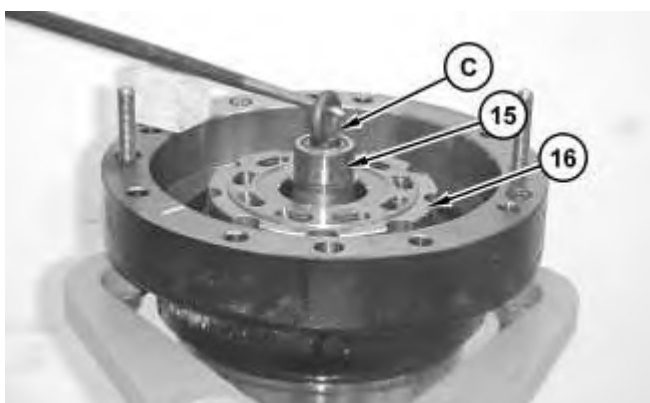

Illustration 8

g02107957

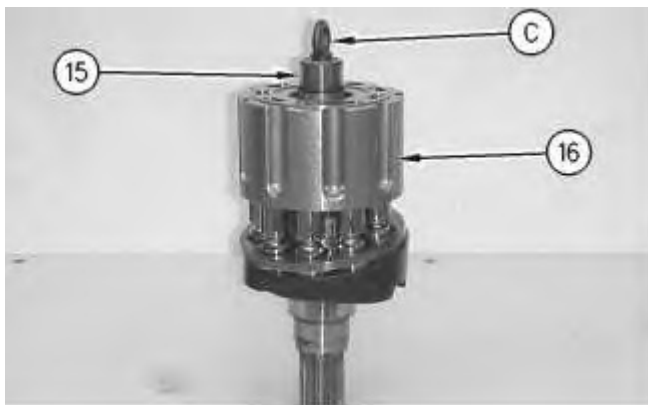

Illustration 9

g00887405

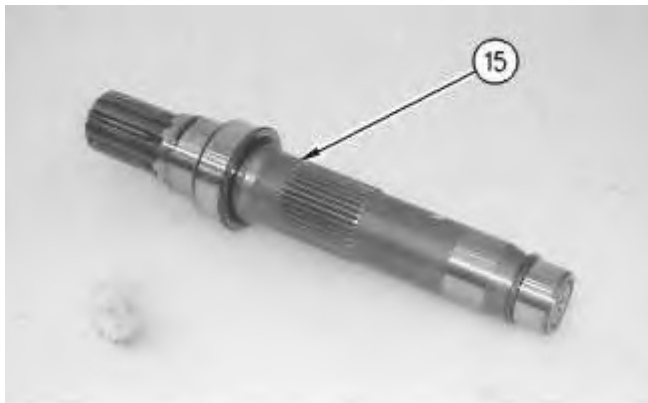

Illustration 10

g00887424

11. Install Tooling (C) into shaft (15). Use a prybar to remove the rotating assembly (16) from the housing.
12. Remove Tooling (C) from shaft (15).
13. Remove shaft (15) from rotating assembly (16).

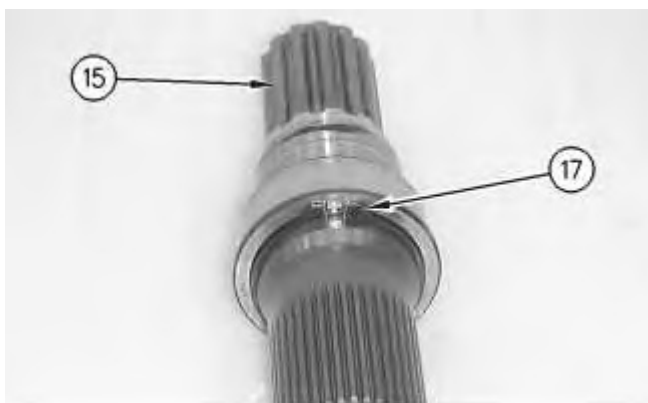

Illustration 11

g00887426

14. Use Tooling (D) to remove retaining ring (17) from shaft (15).

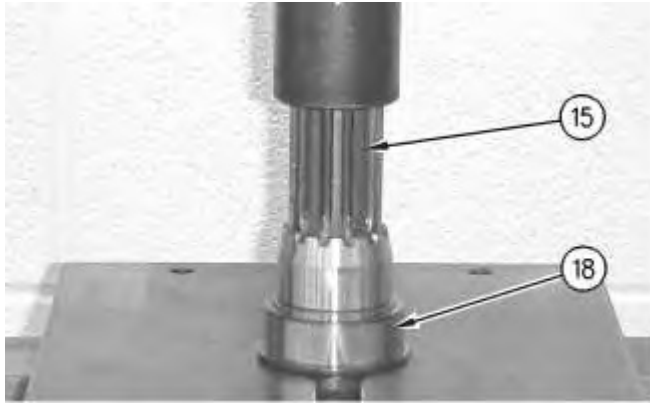

Illustration 12

g00887445

15. Use a suitable press to remove bearing race (18) from shaft (15).

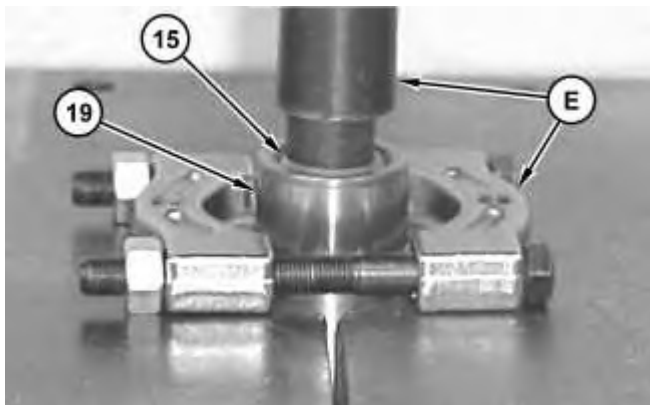

Illustration 13

g03870797

16. Rotate shaft (15). Use a suitable press and Tooling (E) to remove bearing race (19) from shaft (15).



Illustration 14

g03870686

17. Remove cam plate (20) from barrel assembly (16).

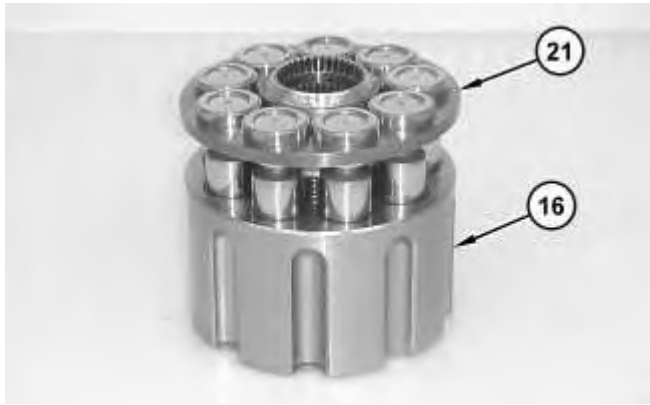

Illustration 15

g03870754

18. Remove piston assemblies and retainer plate (21) from barrel assembly (16).

Note: Place marks on the pistons and the barrel assembly. The pistons must be returned to the original position.

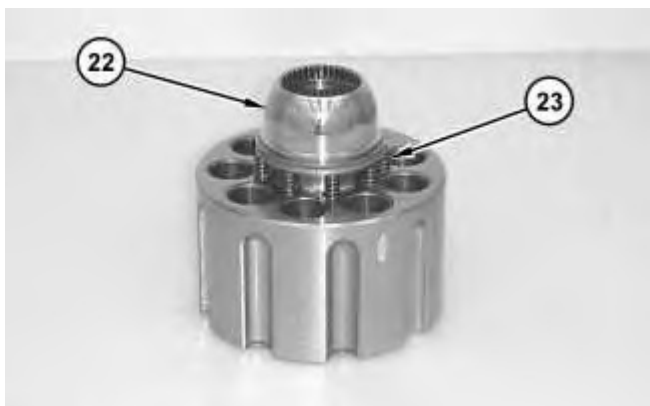

Illustration 16

g03870760

! WARNING

Personal injury can result from being struck by parts propelled by a released spring force.

Make sure to wear all necessary protective equipment.

Follow the recommended procedure and use all recommended tooling to release the spring force.

-
19. Remove ball (22) and springs (23).
-

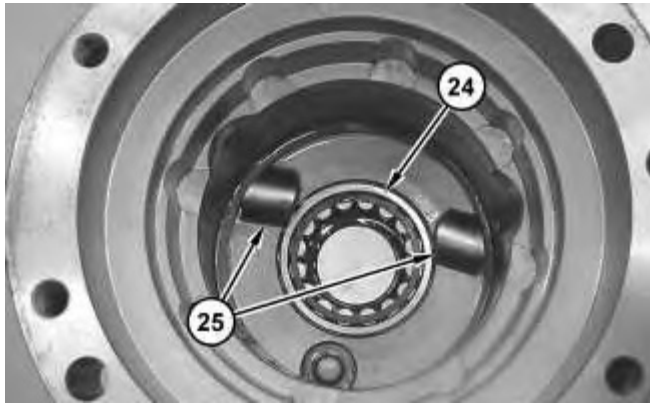

Illustration 17

g03870766

20. Remove bearing (24).
21. Remove keys (25) and locating pins (not shown) from the body of the travel motor.

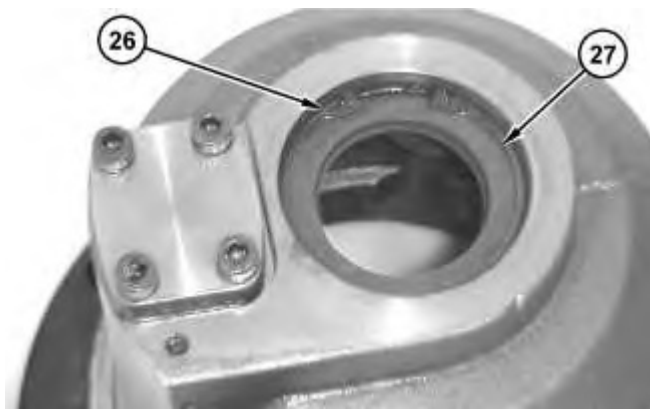

Illustration 18

g03870770

22. Rotate the housing. Use Tooling (F) to remove retaining ring (26).
23. Remove lip seal (27).

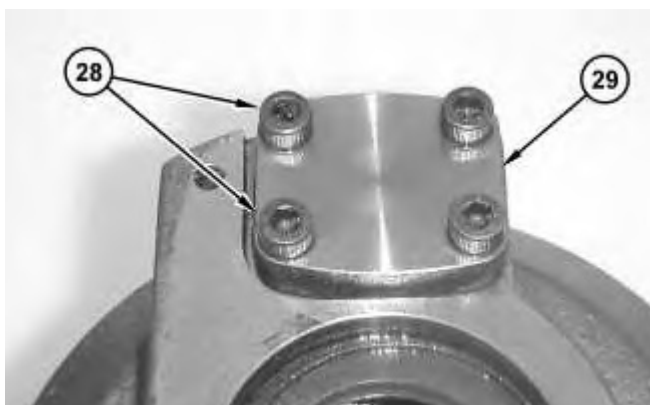

Illustration 19

g03870778

24. Remove bolts (28) and cover (29).



Illustration 20

g03870779

25. Remove seal (30) and backup ring (31).

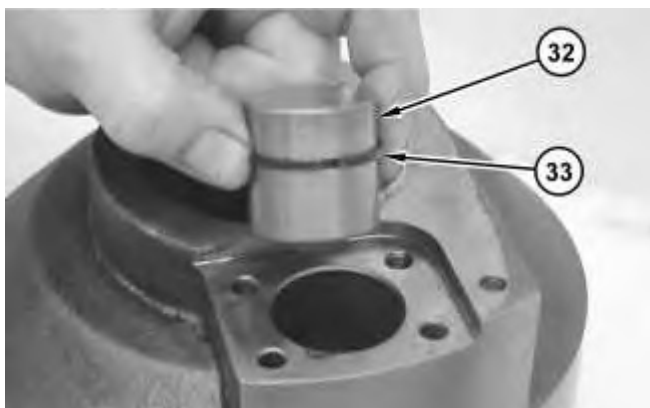

Illustration 21

g03870780

26. Remove piston actuator (32) and seal (33).



Illustration 22

g03870784

27. Remove O-ring seal (34) from the housing of the travel motor.
-

Product: EXCAVATOR

Model: 336D2 L EXCAVATOR GJA

Configuration: 336D2 L Excavators GJA00001-UP (MACHINE) POWERED BY C9 Engine

Disassembly and Assembly 336D 2L and 340D 2L Excavators Machine Systems

Media Number -M0065626-02

Publication Date -01/09/2015

Date Updated -14/12/2017

i07195340

Travel Motor - Disassemble

SMCS - 4351-015

Disassembly Procedure

Table 1

Required Tools			
Tool	Part Number	Part Description	Qty
A	1P-2420	Transmission Repair Stand	1
B	421-5662	Lifting Eye Assembly	1
C	6V-5215	M8 X 1.25 X 16 MM Bolt	2
	9M-1974	M8 Hard Washer	2
D	1P-0510	Driver Gp	1

Start By:

- a. Remove travel motor.

NOTICE

Care must be taken to ensure that fluids are contained during performance of inspection, maintenance, testing, adjusting, and repair of the product. Be prepared to collect the fluid with suitable containers before opening any compartment or disassembling any component containing fluids.

Refer to Special Publication, NENG2500, "Dealer Service Tool Catalog" for tools and supplies suitable to collect and contain fluids on Cat[®] products.

Dispose of all fluids according to local regulations and mandates.

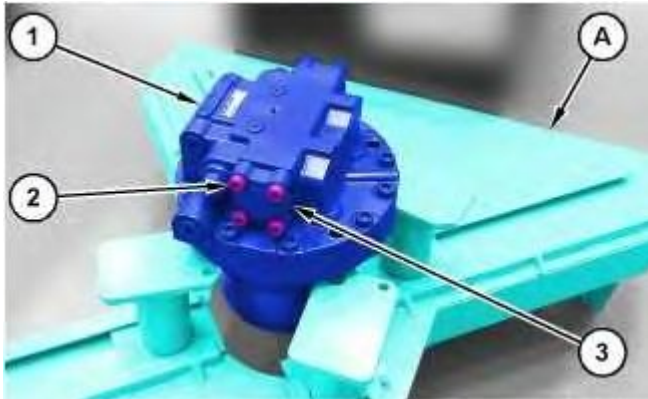

Illustration 1

g06249277

1. Fasten travel motor (1) in a vertical position on Tooling (A). The weight of travel motor (1) is approximately 82 kg (180 lb).

 **WARNING**

Personal injury can result from being struck by parts propelled by a released spring force.

Make sure to wear all necessary protective equipment.

Follow the recommended procedure and use all recommended tooling to release the spring force.

2. Remove bolts (2) and cap (3).

 **WARNING**

Personal injury can result from being struck by parts propelled by a released spring force.

Make sure to wear all necessary protective equipment.

Follow the recommended procedure and use all recommended tooling to release the spring force.

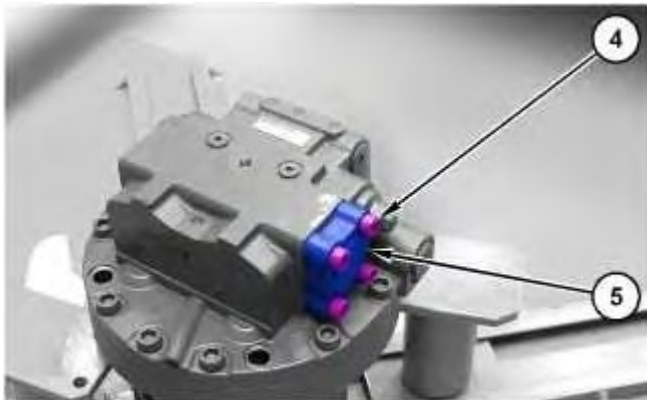

Illustration 2

g06249309

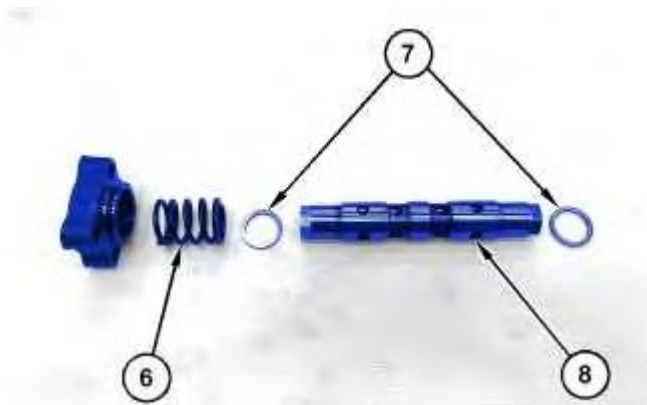

Illustration 3

g06249323



Illustration 4

g06249325

3. Remove bolts (4) and cap (5).
4. Remove spring (6), spring (9), spool assembly (8), and spring seats (7).

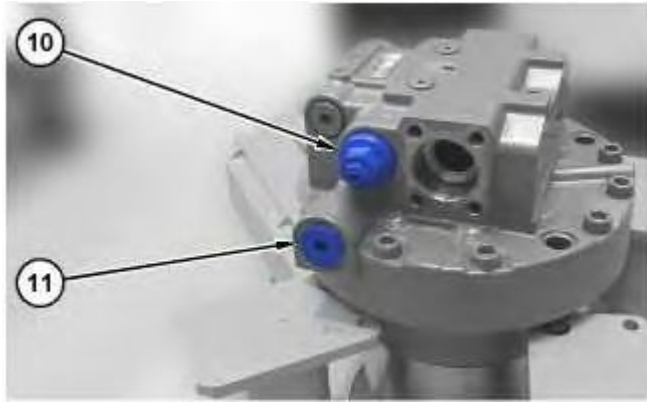

Illustration 5

g06249329

5. Remove plug (11), relief valve (10), and the O-ring seals.

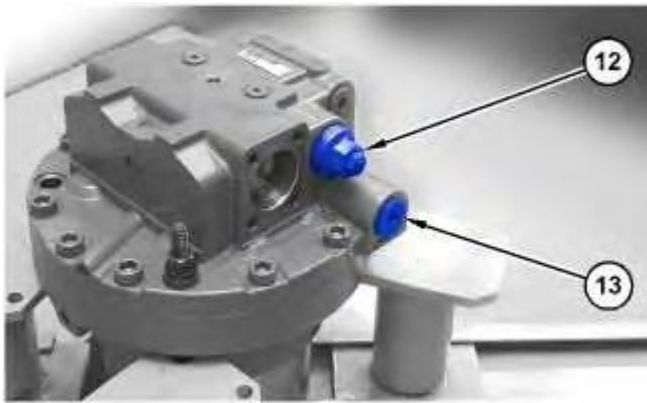

Illustration 6

g06249334

6. Remove plug (13), relief valve (12), and the O-ring seals.

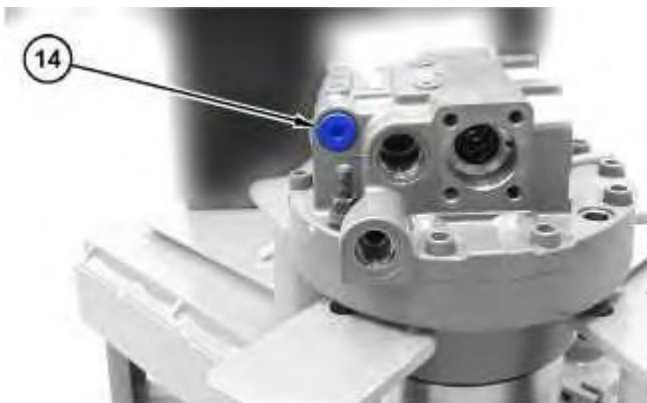

Illustration 7

g06249337

7. Remove plug (14), and the O-ring seal.
-

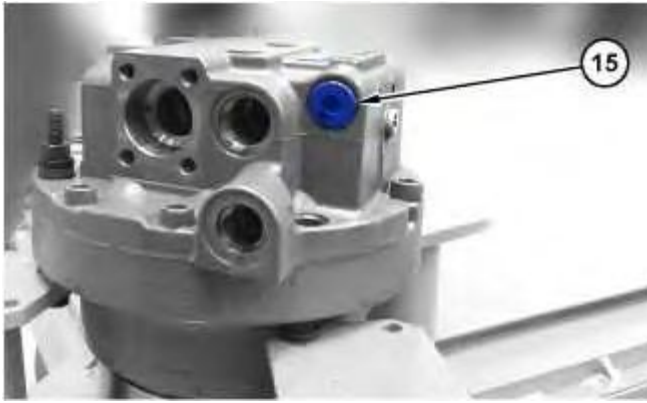

Illustration 8

g06249341

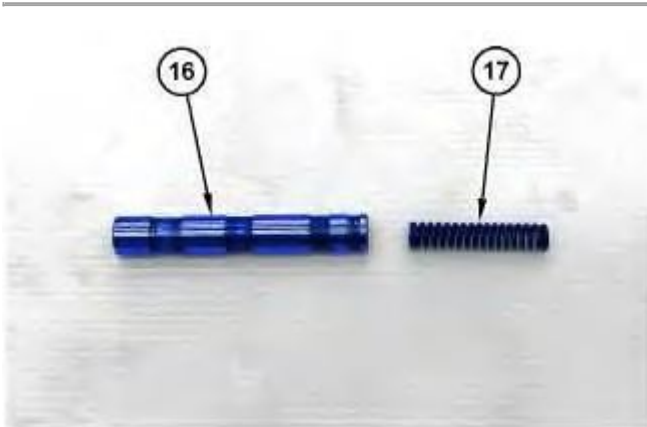

Illustration 9

g06249344

 **WARNING**

Personal injury can result from being struck by parts propelled by a released spring force.

Make sure to wear all necessary protective equipment.

Follow the recommended procedure and use all recommended tooling to release the spring force.

-
8. Remove plug (15), spool assembly (16), spring (17), and the O-ring seals.
-

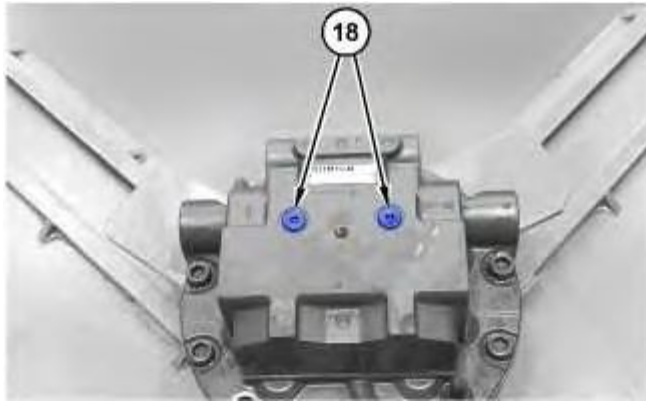

Illustration 10

g06249348

9. Remove plugs (18) and the O-ring seals.

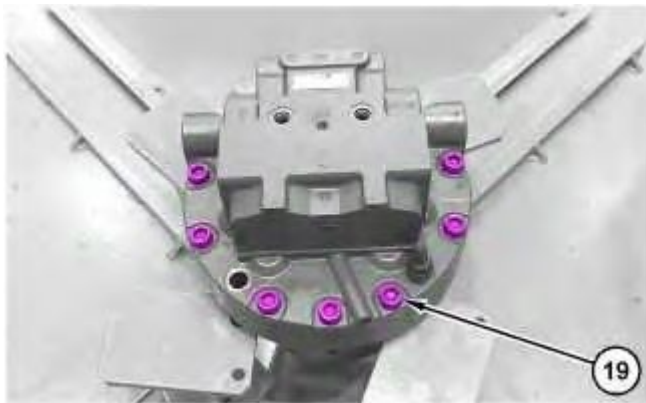

Illustration 11

g06249351

10. Remove bolts (19).



Illustration 12

g06249354

11. Attach Tooling (B) and a suitable lifting device to motor head assembly (20). The weight of motor head assembly (20) is approximately 27 kg (60 lb). Remove motor head assembly (20).



Illustration 13

g06250338

12. Remove the ball bearing that is located on the bottom side of motor head assembly (20).

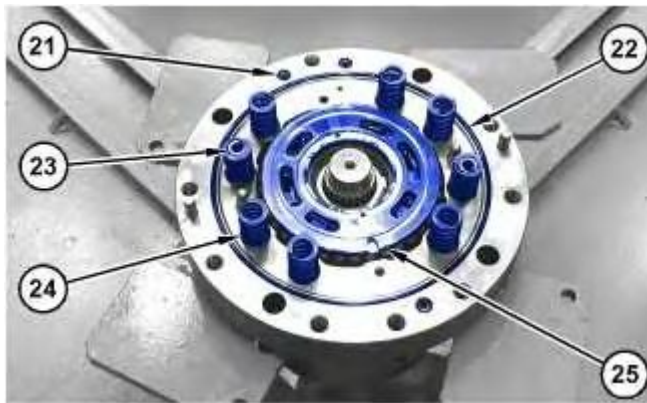

Illustration 14

g06249364

Port plate (25) may still be adhered to the bottom of motor head assembly (20).

13. Remove O-ring seals (21), O-ring seal (22), springs (23), springs (24), and port plate (25).

Note: Note the location of springs (23). They must be installed in the same location during the assembly procedure.



Illustration 15

g06249511

14. Insert Tooling (C) into piston assembly (26). Use a suitable prying device and Tooling (C) to remove piston assembly (26).



Illustration 16

g06250418

15. Remove O-ring seal (27) and O-ring seal (28).



Illustration 17

g06249522

16. Use suitable prying devices to remove guide assembly (29).



Illustration 18

g06249535

17. Remove O-ring seal (30).

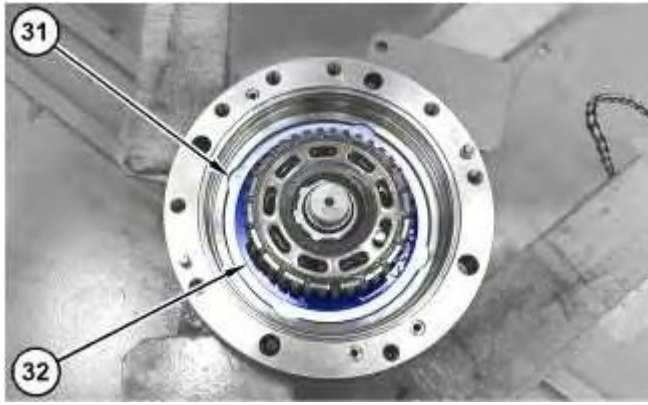

Illustration 19

g06249539

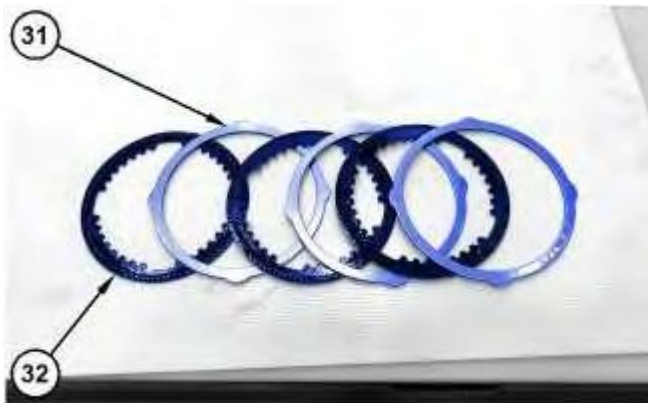

Illustration 20

g06249544

18. Remove separator plates (31) and friction plates (32). Note the alternating order of separator plates (31) and friction plates (32) for assembly purposes.



Illustration 21

g06249564

19. Remove barrel assembly (33).

Note: Do not allow the components of barrel assembly (33) to come apart while you remove barrel assembly (33). The components of barrel assembly (33) must be reinstalled into the original positions.



Illustration 22

g06249598

Note: Mark the component locations for assembly purposes before you disassemble the barrel assembly.

20. Remove piston assemblies (34) and retainer (35).



Illustration 23

g06249609

21. Remove hold down ball (36).



Illustration 24

g06249621

22. Remove dowel pins (37).



Illustration 25

g06249657

23. Put location marks on swashplate (38) for assembly purposes. Remove swashplate (38).



Illustration 26

g06249682

24. Remove pistons (39) and the balls.



Illustration 27

g06249751

25. Remove springs (40).

! WARNING

Personal injury can result from being struck by parts propelled by a released spring force.

Make sure to wear all necessary protective equipment.

Follow the recommended procedure and use all recommended tooling to release the spring force.



Illustration 28

g06249755

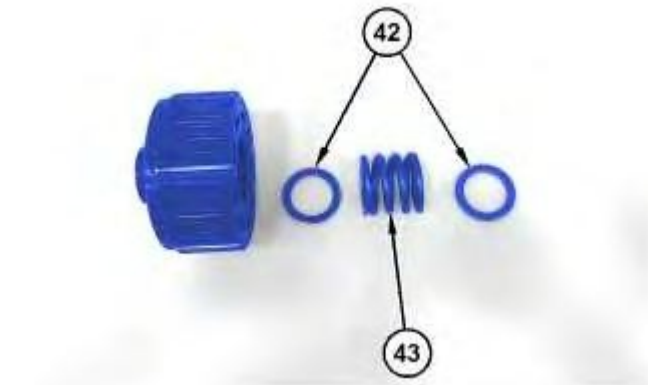

Illustration 29

g06249758

-
26. Use a suitable press and Tooling (D) to remove snap ring (41), spacers (42), and spring (43).
-

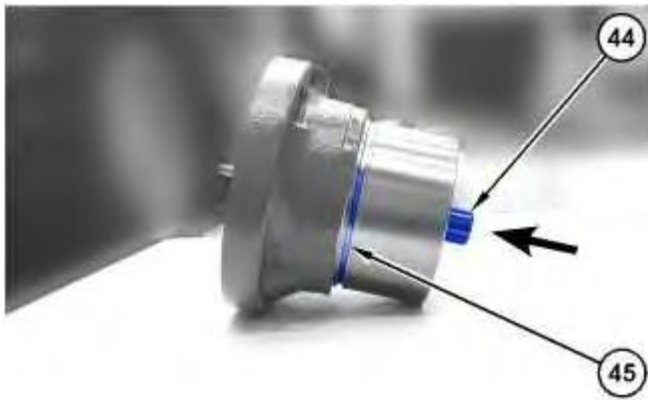

Illustration 30

g06249760

27. Use a soft faced hammer to remove shaft assembly (44). Remove shaft assembly (44) in the direction that is indicated by the arrow.
28. Remove O-ring seal (45).



Illustration 31

g06249762

29. Remove lip seal (46).

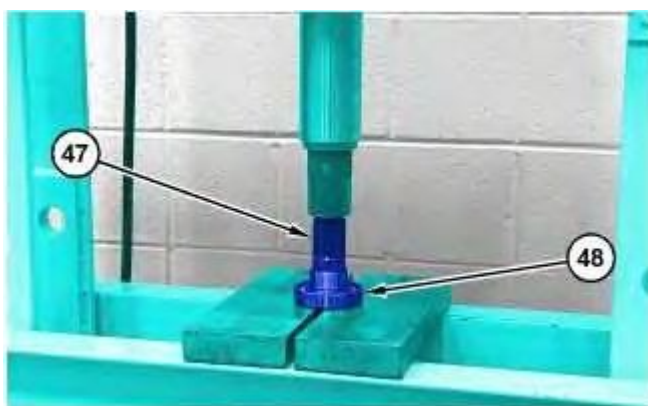

Illustration 32

g06249763

30. Use a suitable press to push shaft (47) out of bearing (48).

Product: EXCAVATOR

Model: 336D2 L EXCAVATOR GJA

Configuration: 336D2 L Excavators GJA00001-UP (MACHINE) POWERED BY C9 Engine

Disassembly and Assembly 336D 2L and 340D 2L Excavators Machine Systems

Media Number -M0065626-02

Publication Date -01/09/2015

Date Updated -14/12/2017

i06242093

Travel Motor - Assemble

SMCS - 4351-016

Assembly Procedure

Table 1

Required Tools			
Tool	Part Number	Part Description	Qty
A	1U-7506	Adapter	1
	8T-4244	Nut	6
	8T-4223	Hard Washer	6
	-	M12 x 1.75 X 250 mm (10 inch) Threaded Rod	1
C	3E-3882	Eyebolt	1
D	1P-1859	Retaining Ring Pliers	1
E	1P-0510	Driver Gp	1
	9S-9152	Bearing Puller Gp	1
F	1P-1861	Retaining Ring Pliers	1
G	-	Loctite 243	-



Illustration 1

g03870784

1. Install O-ring seal (34) onto the housing of the travel motor.



Illustration 2

g03870780

2. Install seal (33) and piston actuator (32). Lubricate the surfaces of piston actuator (32) with lubricant that is being sealed.



Illustration 3

g03870779

3. Install backup ring (31) and seal (30).

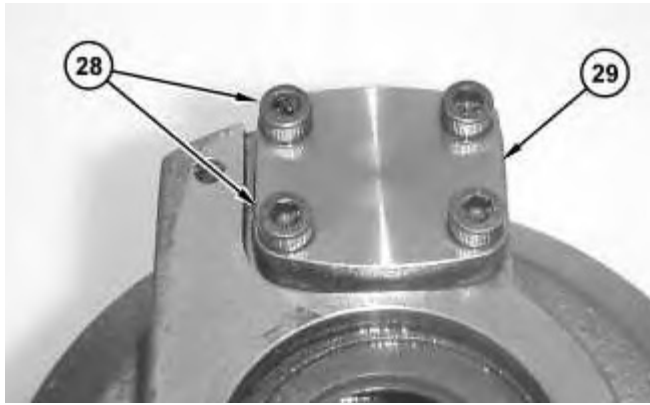

Illustration 4

g03870778

4. Install cover (29) and bolts (28). Tighten bolts (28) to a torque of 28 ± 7 N·m (248 ± 62 lb in).

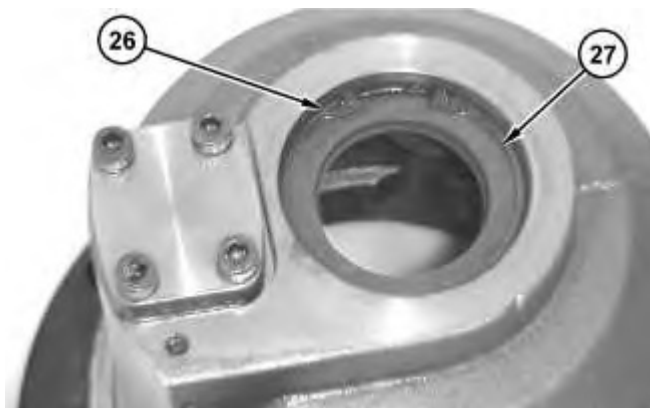

Illustration 5

g03870770

5. Apply Tooling (G) to the mating surface of lip seal (27). Use Tooling (E) in order to install lip seal (27). Lubricate the sealing lip of lip seal (27) with lubricant that is being sealed.
6. Use Tooling (F) in order to install retaining ring (26).

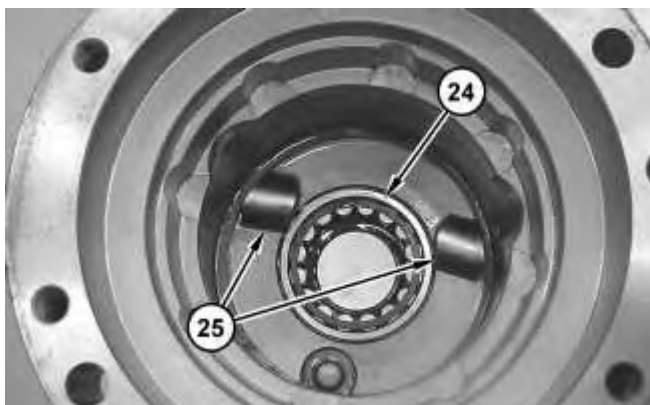

Illustration 6

g03870766



Download the full PDF manual instantly.

Our customer service e-mail:

aservicemanualpdf@yahoo.com