

Product: EXCAVATOR
Model: 330B EXCAVATOR 5EZ
Configuration: ISJ HEX COMMONALITY CHART 5EZ00001-UP (MACHINE)

Disassembly and Assembly 3304B and 3306B Engines for Caterpillar Built Machines

Media Number -SEN5598-09

Publication Date -01/01/2013

Date Updated -25/01/2013

i01041426

Exhaust Manifold - Remove and Install

SMCS - 1059-010

Removal Procedure

Start By:

- A. Remove the turbocharger. Refer to Disassembly and Assembly, "Turbocharger - Remove".

NOTICE

Keep all parts clean from contaminants.

Contaminants may cause rapid wear and shortened component life.

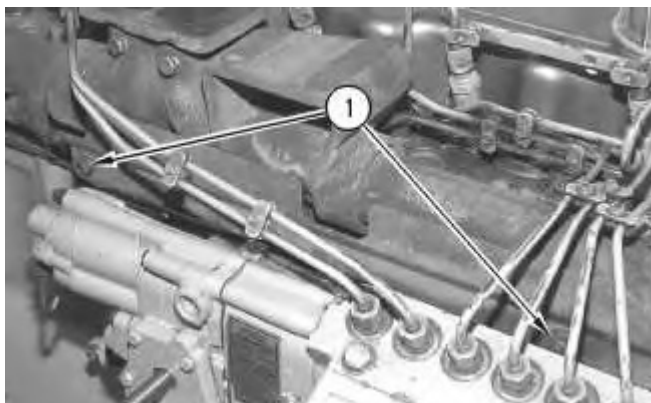

Illustration 1

g00537836

1. Remove two nuts (1), the washers and the heat shield from the exhaust manifold.

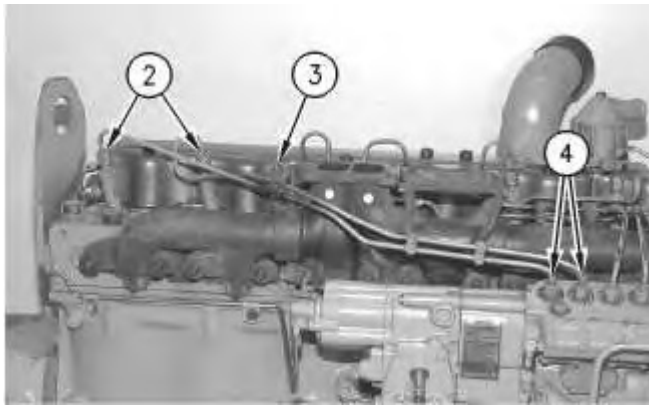

Illustration 2

g00537855

2. Remove bolt (3) from the bracket that holds two of the fuel injection lines in position. Loosen nuts (2) and (4) and remove the two fuel injection lines from the engine. Put protective caps on the fuel injectors and put protective caps on the fuel injection pump in order to prevent contamination.

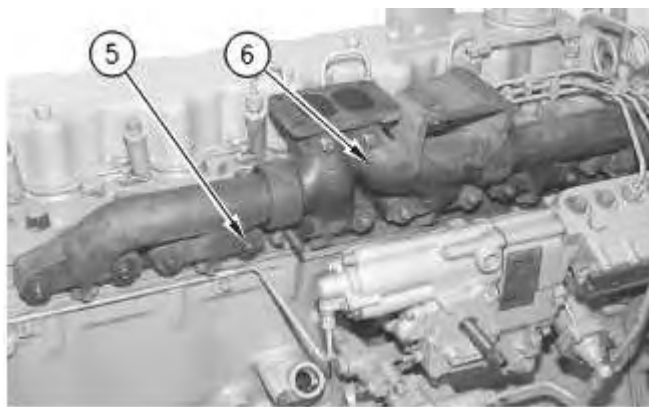

Illustration 3

g00537885

3. Remove the remaining ten exhaust manifold nuts (5) and the large washers. Remove exhaust manifold (6).
-

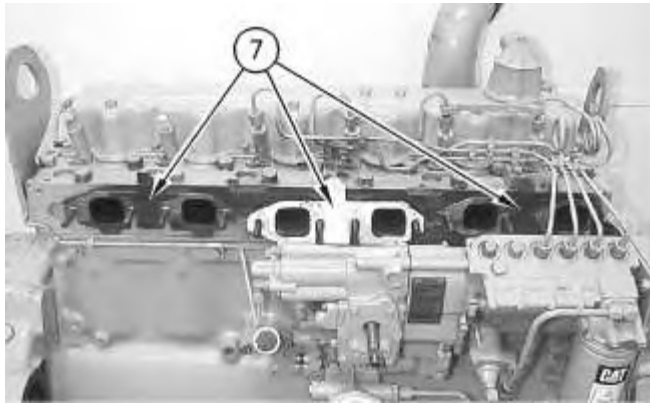

Illustration 4

g00541058

4. Remove three exhaust manifold gaskets (7) from the cylinder head and the twelve exhaust manifold studs, if necessary. Make sure that the position of the two longer studs are marked for proper installation.

Installation Procedure

Table 1

Required Tools			
Tool	Part Number	Description	Qty
A	5P-0144	Fuel Line Socket	1

NOTICE

Keep all parts clean from contaminants.

Contaminants may cause rapid wear and shortened component life.

1. If the twelve exhaust manifold studs were removed, apply **5P-3931** Anti-Seize Compound to both ends of the exhaust manifold studs and install the studs in the cylinder head. Make sure that the two longer studs are installed in the correct position. Tighten the studs to a torque of 27 ± 4 N·m (20 ± 3 lb ft).
-

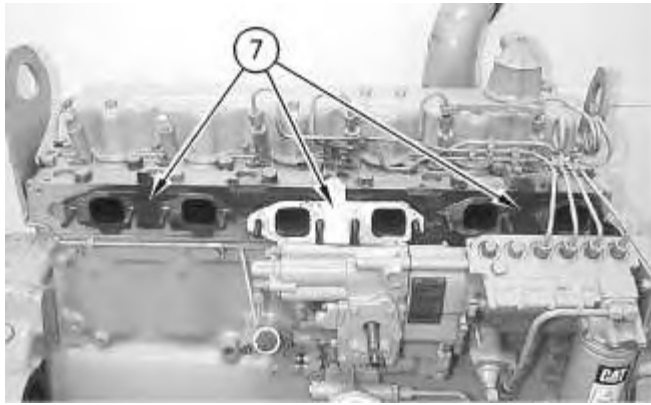

Illustration 5

g00541058

- Put three exhaust manifold gaskets (7) in position on the cylinder head.

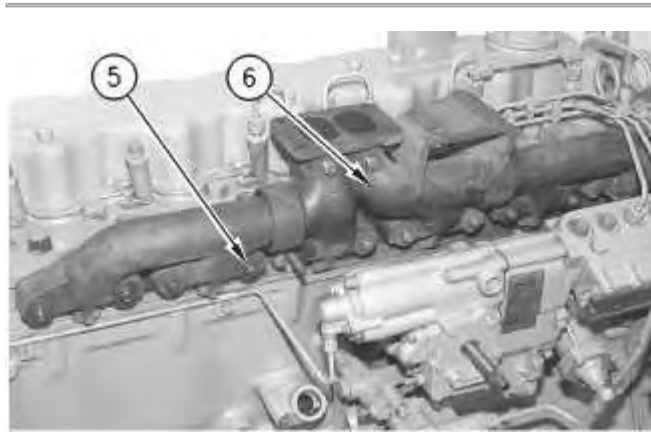

Illustration 6

g00537885

- Install exhaust manifold (6). Install ten washers and nuts (5). The two longer studs are for the installation of the heat shield. Tighten exhaust manifold nuts (5) to a torque of 47 ± 4 N·m (35 ± 3 lb ft).

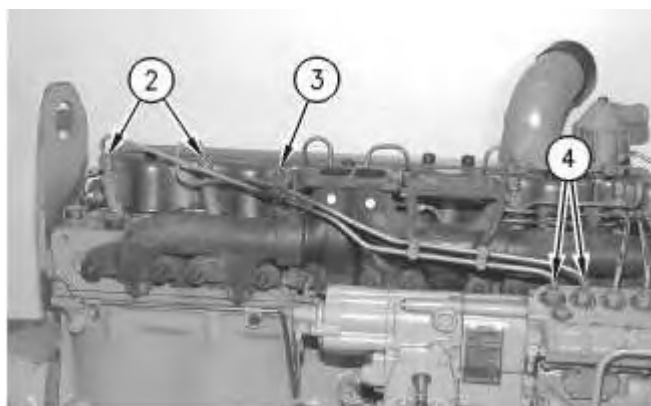

Illustration 7

g00537855

4. Remove the protective caps from the fuel injectors and the fuel injection pump. Put the fuel injection lines in position and tighten nuts (2) and (4) finger tight. Install bolt (3) in the bracket that holds the fuel injection lines in position. Tighten nuts (3) and (4) with Tool (A) to a torque of $40 \pm 7 \text{ N}\cdot\text{m}$ ($30 \pm 5 \text{ lb ft}$).

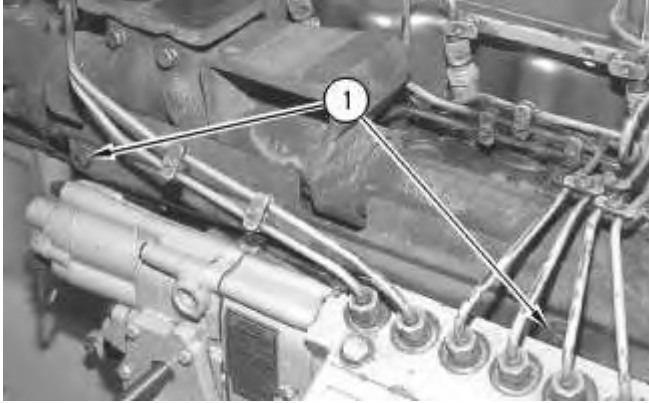

Illustration 8

g00537836

5. Install the two large washers and the spacers on the two remaining exhaust manifold studs. Install heat shield (1) and the remaining two washers and exhaust manifold nuts that fasten heat shield (1) to the exhaust manifold. Tighten the two nuts to a torque of $47 \pm 4 \text{ N}\cdot\text{m}$ ($35 \pm 3 \text{ lb ft}$).
6. Prime the fuel system. Refer to the Operation and Maintenance Manual, "Fuel system - Prime" topic (Maintenance Section).

End By: Install the turbocharger. Refer to Disassembly and Assembly, "Turbocharger - Install".

Product: EXCAVATOR
Model: 330B EXCAVATOR 5EZ
Configuration: ISJ HEX COMMONALITY CHART 5EZ00001-UP (MACHINE)

Disassembly and Assembly 3304B and 3306B Engines for Caterpillar Built Machines

Media Number -SEN5598-09

Publication Date -01/01/2013

Date Updated -25/01/2013

i00962627

Inlet and Exhaust Valves - Remove and Install

SMCS - 1105-010

Removal Procedure

Table 1

Required Tools			
Tool	Part Number	Part Description	Qty
A	5S-1330	Valve Spring Compressor	1
B	8S-2263	Valve Spring Tester	1

Start By:

- A. Remove the cylinder head. Refer to Disassembly and assembly, "Cylinder Head - Remove".

NOTICE

Keep all parts clean from contaminants.

Contaminants may cause rapid wear and shortened component life.

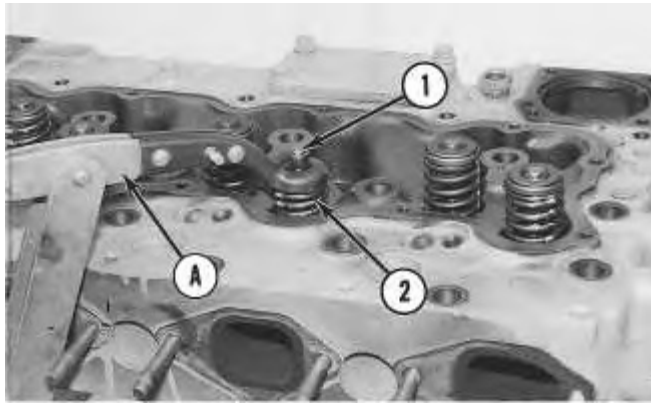

Illustration 1

g00490614

1. Use Tool (A) to compress valve spring (2) and remove valve keepers (1) .
2. Remove Tool (A), the rotocoil, the valve spring and the valve stem oil shield. Remove the valve from the cylinder head. Put identification marks on the valves for installation purposes.

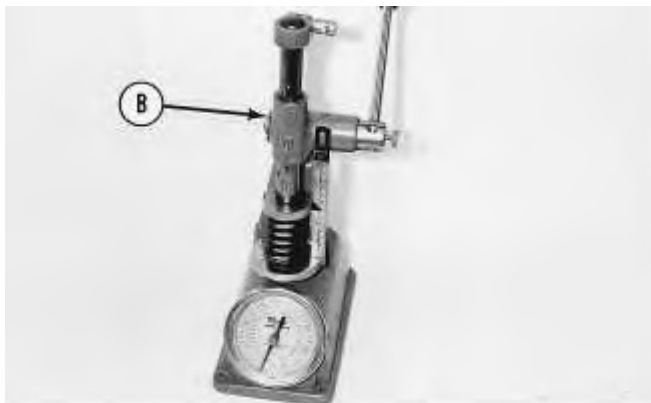

Illustration 2

g00490682

3. Check the valve spring force with Tool (B). Refer to Specifications, "Cylinder Head Valves" for information on the valve springs.
4. Perform Steps 1 through 3 for the remaining inlet and exhaust valves.

Installation Procedure

Table 2

Required Tools			
Tool	Part Number	Part Description	Qty
A	5S-1330	Valve Spring Compressor	1
B	5S-1322	Valve Keeper Inserter	1

NOTICE

Keep all parts clean from contaminants.

Contaminants may cause rapid wear and shortened component life.

1. Lubricate the inlet and exhaust valves with clean engine oil. Install the inlet and exhaust valves in the original location in the cylinder head.

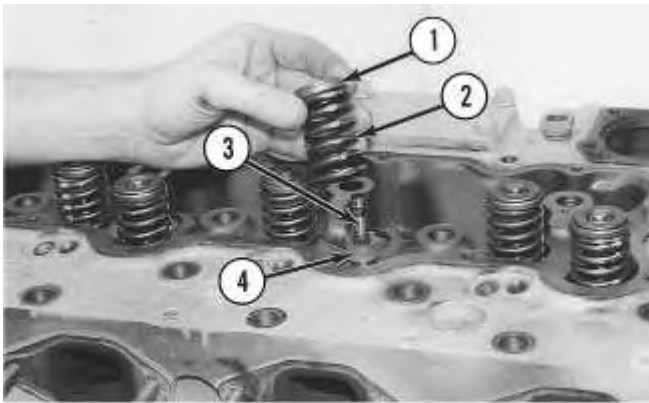

Illustration 3

g00508681

2. Install valves (3), oil shield (4), valve spring (2) and rotocoil (1) in the cylinder head.

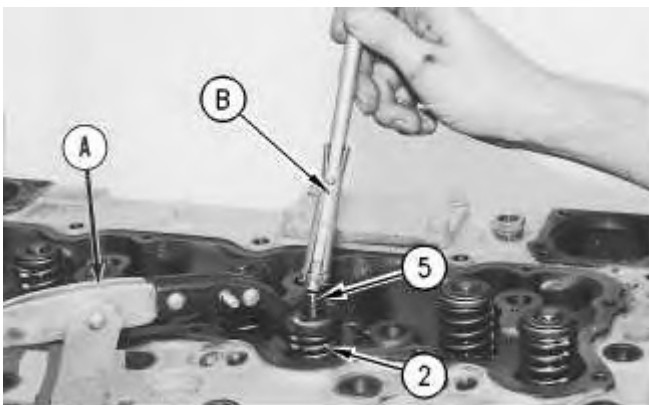

Illustration 4

g00490777

3. Use Tool (A) to compress valve spring (2). Install valve keeper (5) on the valve stem with Tool (B) .



WARNING

The valve keepers can be thrown from the valve when the valve spring compressor is released. Ensure that the valve keepers are properly installed on the valve stem. To help prevent personal injury, keep away from the front of the valve keepers and valve springs during the installation of the valves.

4. Carefully remove Tool (A). Strike the top of the valve with a soft faced hammer in order to ensure that the valve keepers are properly installed.
5. Repeat Steps 3 through 4 for the remaining inlet and exhaust valves.

End By: Install the cylinder head. Refer to Disassembly and Assembly, "Cylinder Head - Remove and Install".

Product: EXCAVATOR
Model: 330B EXCAVATOR 5EZ
Configuration: ISJ HEX COMMONALITY CHART 5EZ00001-UP (MACHINE)

Disassembly and Assembly 3304B and 3306B Engines for Caterpillar Built Machines

Media Number -SEN5598-09

Publication Date -01/01/2013

Date Updated -25/01/2013

i00962891

Inlet and Exhaust Valve Guides - Remove and Install

SMCS - 1104-010

Removal Procedure

Table 1

Required Tools			
Tool	Part Number	Part Description	Qty
A	9U-7349	Valve Guide Driver	1

Start By:

- A. Remove the inlet and exhaust valves. Refer to Disassembly and Assembly, "Inlet and Exhaust Valves - Remove and Install".

NOTICE

Keep all parts clean from contaminants.

Contaminants may cause rapid wear and shortened component life.

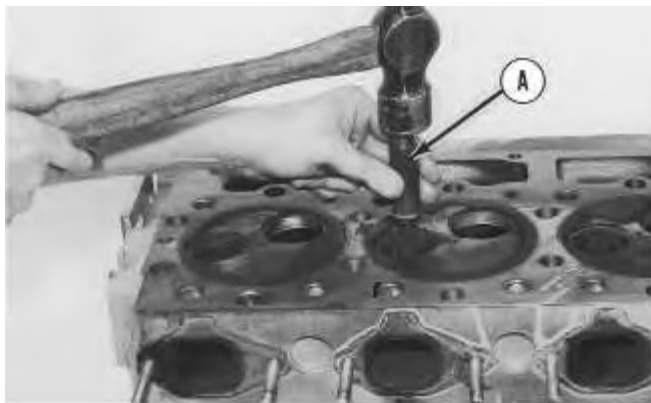

Illustration 1

g00490787

1. Use Tool (A) to remove the inlet and exhaust valve guides from the cylinder head.
2. Repeat Step 1 for the remaining inlet and exhaust valve guides.

Installation Procedure

Table 2

Required Tools			
Tool	Part Number	Part Description	Qty
A	9U-7349	Valve Guide Driver	1
B	9U-6954	Valve Guide Collar	1

NOTICE

Keep all parts clean from contaminants.

Contaminants may cause rapid wear and shortened component life.

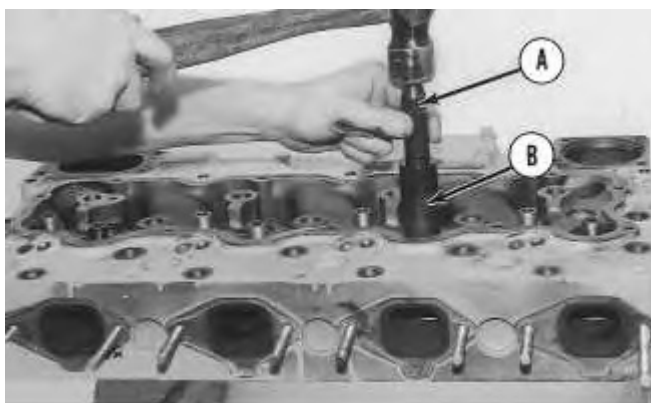

1. Put clean engine oil on the outside diameter of the valve guide. Install the valve guide with Tool (A) and Tool (B), as shown.

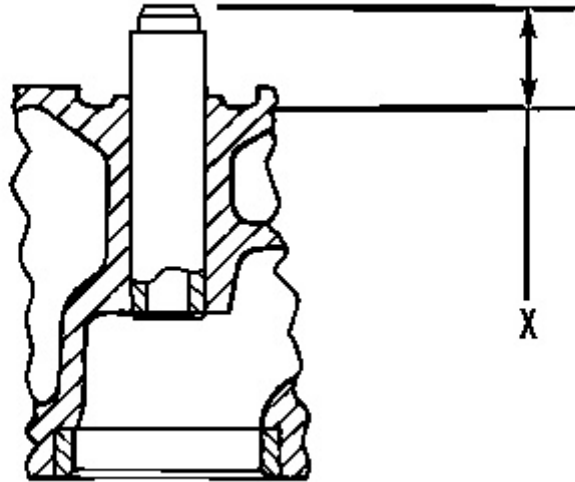

2. Dimension (X) from the top of the valve guide to the cylinder head must be 22.23 ± 0.25 mm (0.875 ± 0.010 inch). For more information on the inlet and exhaust valve guides, refer to Specifications, "Cylinder Head Valves".

Note: In order to help prevent damage to the valve guides, Tool (B) must be used during installation.

3. Repeat Steps 1 and 2 for the remaining inlet and exhaust valve guides.

End By: Install the inlet and exhaust valves. Refer to Disassembly and Assembly, "Inlet and Exhaust Valves - Remove and Install".

Product: EXCAVATOR
Model: 330B EXCAVATOR 5EZ
Configuration: ISJ HEX COMMONALITY CHART 5EZ00001-UP (MACHINE)

Disassembly and Assembly 3304B and 3306B Engines for Caterpillar Built Machines

Media Number -SEN5598-09

Publication Date -01/01/2013

Date Updated -25/01/2013

i02107684

Inlet and Exhaust Valve Seat Inserts - Remove and Install

SMCS - 1103-010

Removal Procedure

Table 1

Required Tools			
Tool	Part Number	Part Description	Qty
A	6V-4805	Valve Seat Extractor Tool Group	1

Start By:

- A. Remove the inlet and exhaust valves. Refer to Disassembly and Assembly, "Inlet and Exhaust Valves - Remove and Install".

NOTICE

Keep all parts clean from contaminants.

Contaminants may cause rapid wear and shortened component life.

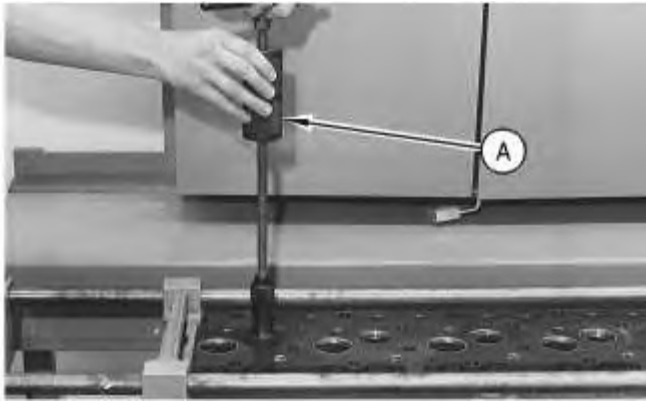

Illustration 1

g00490857

1. Use Tooling (A) in order to remove the valve seat insert from the cylinder head.
2. Clean the valve seat in the cylinder head. Remove any rough areas from the valve seat in the cylinder head.
3. Repeat Steps 1 and 2 for the remaining inlet valve seat inserts and exhaust valve seat inserts.

Installation Procedure

Table 2

Required Tools			
Tool	Part Number	Part Description	Qty
A	6V-4805	Valve Seat Extractor Tool Group	1

NOTICE

Keep all parts clean from contaminants.

Contaminants may cause rapid wear and shortened component life.

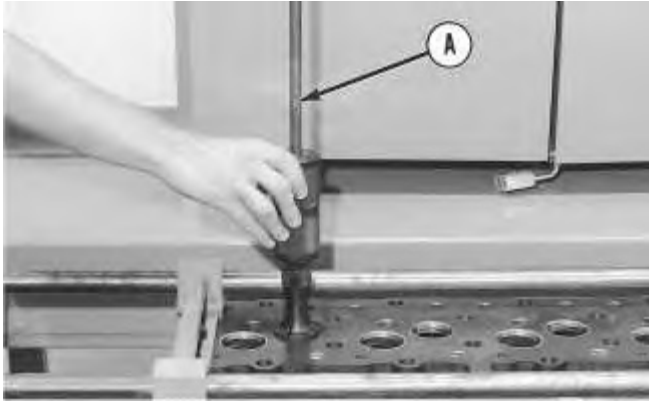

Illustration 2

g00508515

1. Shrink the new valve insert with reduced temperature. Use Tooling (A) in order to install the new valve seat insert in the cylinder head.

Note: Do not increase the diameter of the extractor in the valve seat insert when the insert is installed in the cylinder head.

2. Repeat Step 1 for the remaining inlet valve seat inserts and exhaust valve seat inserts.

End By: Install the inlet and exhaust valves. Refer to Disassembly and Assembly, "Inlet and Exhaust Valves - Remove and Install".

Product: EXCAVATOR
Model: 330B EXCAVATOR 5EZ
Configuration: ISJ HEX COMMONALITY CHART 5EZ00001-UP (MACHINE)

Disassembly and Assembly 3304B and 3306B Engines for Caterpillar Built Machines

Media Number -SEN5598-09

Publication Date -01/01/2013

Date Updated -25/01/2013

i00981264

Engine Oil Filter Base - Remove

SMCS - 1306-011

Removal Procedure

Table 1

Required Tools			
Tool	Part Number	Part Description	Qty
A	2P-8250	Strap Wrench Assembly	1

NOTICE

Keep all parts clean from contaminants.

Contaminants may cause rapid wear and shortened component life.

NOTICE

Care must be taken to ensure that fluids are contained during performance of inspection, maintenance, testing, adjusting and repair of the machine. Be prepared to collect the fluid with suitable containers before opening any compartment or disassembling any component containing fluids.

Refer to Special Publication, NENG2500, "Caterpillar Tools and Shop Products Guide", for tools and supplies suitable to collect and contain fluids in Caterpillar machines.

Dispose of all fluids according to local regulations and mandates.

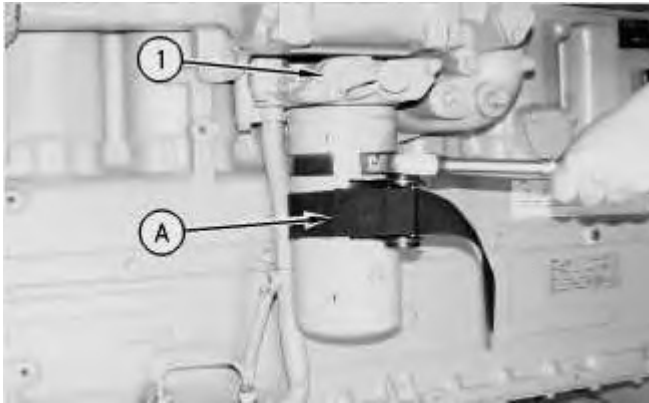

Illustration 1

g00499430

1. Remove the oil filter from engine oil filter base (1) with Tool (A).

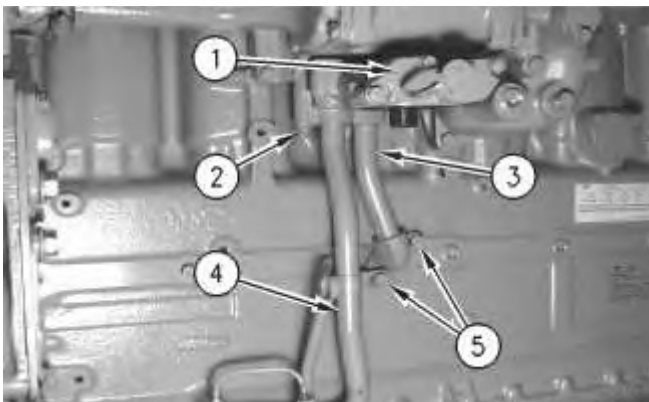

Illustration 2

g00499568

2. Remove bolts (5), tube assembly (3) and the gasket. Remove the O-ring seal in tube assembly (3) and replace the O-ring seal, if necessary.
 3. Remove the bolts that hold tube assembly (4) to the cylinder block. Remove tube assembly (4) and the gasket. Remove the O-ring seal in tube assembly (4) and replace the O-ring seal, if necessary.
 4. Remove four bolts (2) and engine oil filter base (1) from the cylinder block. Remove the O-ring seals from engine oil filter base (1), if necessary.
-

Product: EXCAVATOR
Model: 330B EXCAVATOR 5EZ
Configuration: ISJ HEX COMMONALITY CHART 5EZ00001-UP (MACHINE)

Disassembly and Assembly 3304B and 3306B Engines for Caterpillar Built Machines

Media Number -SEN5598-09

Publication Date -01/01/2013

Date Updated -25/01/2013

i00983225

Engine Oil Filter Base - Disassemble

SMCS - 1306-015

Disassembly Procedure

Start By:

- A. Remove the engine oil filter and the engine oil filter base. Refer to Disassembly and Assembly, "Engine Oil Filter Base - Remove".

NOTICE

Keep all parts clean from contaminants.

Contaminants may cause rapid wear and shortened component life.

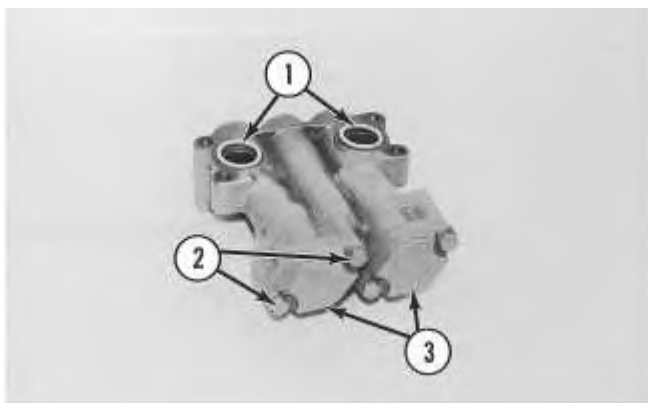

Illustration 1

g00500551

Typical Example

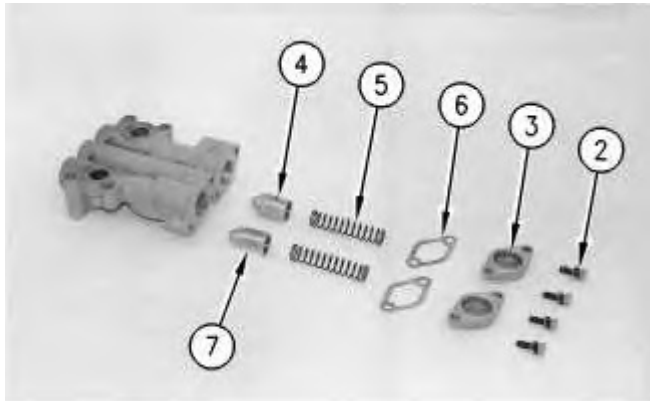

Illustration 2

g00500559

Typical Example

1. Remove O-ring seals (1) from the engine oil filter base. Remove four bolts (2), two covers (3) and two gaskets (6) .

Note: Plunger (4) is for the oil filter bypass. Plunger (7) is for the engine oil cooler bypass.

2. Remove springs (5), plunger (4) and plunger (7) from the engine oil filter base.
-

Product: EXCAVATOR
Model: 330B EXCAVATOR 5EZ
Configuration: ISJ HEX COMMONALITY CHART 5EZ00001-UP (MACHINE)

Disassembly and Assembly 3304B and 3306B Engines for Caterpillar Built Machines

Media Number -SEN5598-09

Publication Date -01/01/2013

Date Updated -25/01/2013

i00983561

Engine Oil Filter Base - Assemble

SMCS - 1306-016

Assembly Procedure

NOTICE

Keep all parts clean from contaminants.

Contaminants may cause rapid wear and shortened component life.

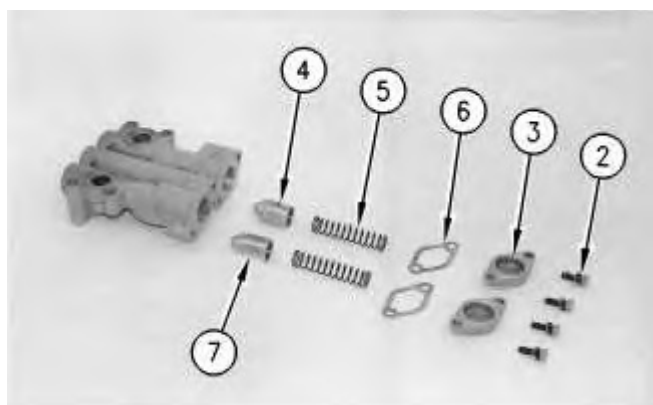

Illustration 1

g00500559

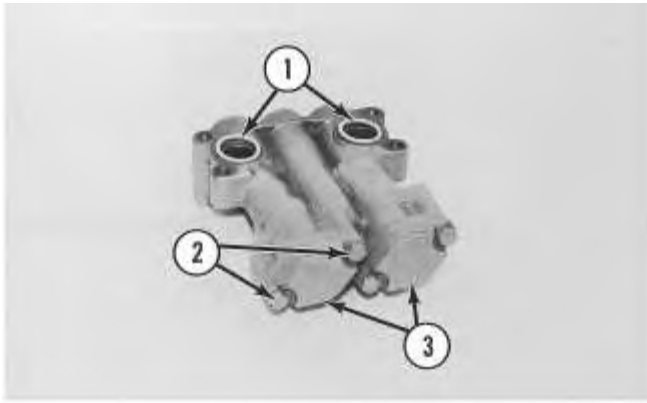

Illustration 2

g00500551

1. Install plunger (7), plunger (4) and springs (5) .

Note: Plunger (7) is for the engine oil cooler bypass. Plunger (4) is for the oil filter bypass.

Note: Check the condition of the O-ring seals and gaskets. If the seals or gaskets are worn or damaged, use new parts for replacement.

2. Install two gaskets (6), two covers (3), four bolts (2) and O-ring seals (1) .

End By: Install the engine oil filter base and the oil filter. Refer to Disassembly and Assembly, "Engine Oil Filter Base - Install".

Product: EXCAVATOR
Model: 330B EXCAVATOR 5EZ
Configuration: ISJ HEX COMMONALITY CHART 5EZ00001-UP (MACHINE)

Disassembly and Assembly 3304B and 3306B Engines for Caterpillar Built Machines

Media Number -SEN5598-09

Publication Date -01/01/2013

Date Updated -25/01/2013

i00981970

Engine Oil Filter Base - Install

SMCS - 1306-012

Installation Procedure

Table 1

Required Tools			
Tool	Part Number	Part Description	Qty
A	2P-8250	Strap Wrench Assembly	1

NOTICE

Keep all parts clean from contaminants.

Contaminants may cause rapid wear and shortened component life.

1. Check the condition of the O-ring seals and the gaskets. If the seals or the gaskets are worn or damaged, use new parts for replacement.
-

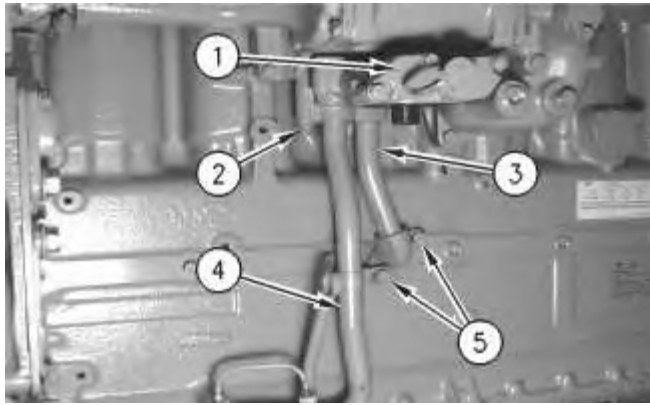

Illustration 1

g00499568

Note: Coat all of the O-ring seals with clean engine oil prior to installation.

2. Put the O-ring seals on engine oil filter base (1). Install engine oil filter base (1) on the cylinder block with four bolts (2) .
3. Put the O-ring seal and the gasket in position on tube assembly (4). Install tube assembly (4) on the cylinder block. Install the bolts that hold tube assembly (4) in position.
4. Put the O-ring seal and the gasket in position on tube assembly (3). Fasten the clip to tube assembly (4). Position tube assembly (3) onto the cylinder block and install bolts (5).

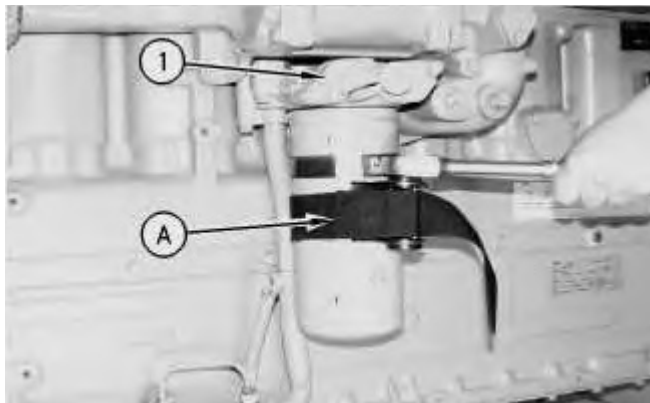

Illustration 2

g00499430

5. Install engine oil filter (1) with Tool (A) .

Note: Follow the installation procedure on the engine oil filter in order to install the engine oil filter on the engine oil filter base.



Download the full PDF manual instantly.

Our customer service e-mail:

aservicemanualpdf@yahoo.com